



INFORMATION UNLIMITED

THE HUMAN FACTOR

The Future of Human-Machine Collaborations

zenon Security Q&A

HTML5: A Look Under the Hood



GLOBAL

x

Partner
Academy

x



COPADATA

Inspiration

Experts

Growing Together

Face-to-Face

COPA-DATA

GPA 2016

Partner Community

zenon

Knowledge

Munich Save the Date

Networking

Fun

Global Partner Academy

Customer Experiences

Straight-forward

June 15-16, 2016

Find out more at

www.copadata.com/GPA

IU**INFORMATION UNLIMITED**

THE COPA-DATA MAGAZINE

ISSUE #28 | OCTOBER 2015

PRESIDENT AND PUBLISHER:

Thomas Punzenberger
 Ing. Punzenberger COPA-DATA GmbH
 Karolingerstrasse 7b, 5020 Salzburg, Austria
 Commercial Register Number: FN56922i
 t +43 (0)662 43 10 02-0
 f +43 (0)662 43 10 02-33
 www.copadata.com

EDITOR-IN-CHIEF: Julia Angerer**EDITORIAL TEAM:**

Gernot Bugram, Eva-Maria Oberauer-Dum, Steve Poynter, Nicola Richter, Esther Rutter, Phillip Werr, Bertold Wöss

ART DIRECTOR: Manuela Bacher**DESIGN SUPPORT:** Lisa Mitterbuchner**COPY-EDITING:** Kristen Kopp**AUTHORS/CONTRIBUTORS:**

Emilian Axinia, Sebastian Bäsken, Piotr Dąbrowski, Lisette Lillo Fagerstedt, Gero Gruber, Robert Harrison, Markus Helbok, Stefan Hufnagl, Thomas Lehrer, Reinhard Mayr, Hermann Oswald, Dr. Matthias Peissner, Johannes Petrowisch, Thomas Punzenberger, Jürgen Resch, Symeon Rizos, Philipp Schmidt, Bernd Wimmer, Hans-Peter Ziegler

PRINT OFFICE:

Offset 5020 Druckerei & Verlag Ges.m.b.H., Bayernstrasse 27, 5072 Siezenheim, Austria,
LETTERSHOP & DISTRIBUTION:
 Mailinghaus GmbH Dialog Marketing Agentur, Neualmerstrasse 37, 5400 Hallein, Austria
 PRINT RUN: 13,500 copies
 FREQUENCY: twice a year

COPYRIGHT:

© Ing. Punzenberger COPA-DATA GmbH. All rights reserved. The magazine and all the articles and images it contains are protected by copyright. Any use or duplication is not permitted without prior permission from the editorial team. The technical data contained herein has been provided solely for informational purposes and is not legally binding. zenon®, zenon Analyzer®, zenon Supervisor®, zenon Operator®, zenon Logic® and straton® are trademarks registered by Ing. Punzenberger COPA-DATA GmbH. All other brands or product names may be the trademarks of their representative owners and have not been specifically earmarked. We thank all contributors for their friendly support and the pictures they provided. Subject to change - technical, print or otherwise.

CONTENT

- 5 Editorial
- 6 **SPOTLIGHT THE HUMAN FACTOR**
- 7 The Human Factor in the Smart Factory
- 11 Guest Contribution: HMI 4.0
The Future of Human-Machine Collaborations
- 14 A Blast from the zenon Past with COPA-DATA Founder and CEO Thomas Punzenberger
- 18 **PRODUCTS & SERVICES**
- 20 Series: Efficient Engineering with zenon [PART 5/2]
Multi-project Administration
- 24 How you Secure your Smart Factory
zenon Security Q&A
- 28 HTML5: Interface of the Future?
- 30 Energy Data Management with a Certain Something
- 34 **INDUSTRIES & SOLUTIONS**
- 36 3D Technology in zenon
- 40 IEC 61850: from XML to HMI in a Few Minutes
- 42 zenon Success Story at Jernbaneverket in Norway
- 44 From Machine Construction to Equipment Ramp-up
Life in the Fast Lane with zenon
- 46 EU Guidelines for Good Manufacturing Practice in Pharma:
Revision of Annex 15
- 50 **AROUND THE WORLD**
- 52 It's Showtime!
COPA-DATA Gets Equipped for the Future
- 57 Who is Who
- 60 COPA-DATA Partner Community
Introducing zenon Certification



linkedin.com/company/copa-data-headquarters
 gplus.to/COPADATA
 facebook.com/COPADATAHeadquarters
 twitter.com/copadata
 xing.com/companies/copa-data
 youtube.com/copadatavideos



CONTACT/
 FREE SUBSCRIPTION:

IU@COPADATA.COM
 WWW.COPADATA.COM/IU

EDITORIAL



Dear readers,

The end of the year push is already in motion, for our teams – and for our customers. Many trade fairs, visits and meetings have yet to be completed. The predominant topics are still Industry 4.0, Internet of Things and Energy Management.

But despite all the innovations and technical evolution, we should not forget the humans that operate this technology. Even if the goal is often an unmanned production, humans are still behind the scenes somewhere, those who made it all possible from the start. People that design and build this equipment – and then later run it.

In order to make their lives easier and offer them the right assistance, we already embraced the subject of ergonomics many years ago. Ergonomics encompasses not only simple engineering and comfortable equipment handling, but also robust operations. This allows users to concentrate on their main tasks. A reliably functioning plant offers a company carefree operation and generally a higher level of efficiency too, which in turn brings about greater productivity.

The Smart Factory of Industry 4.0 will not only fundamentally change our production environment, but have an effect on the role of the humans in these networked infrastructures. How will humans and machines collaborate in the future? Will machines take over our tasks? What is the role of the “human factor” in industry? You can find the answer to this and many more questions in this edition of the *IU*.

With this in mind, I wish you an exciting read!

A handwritten signature in blue ink, appearing to read 'TP', written over a light blue circular watermark.

THOMAS PUNZENBERGER, CEO

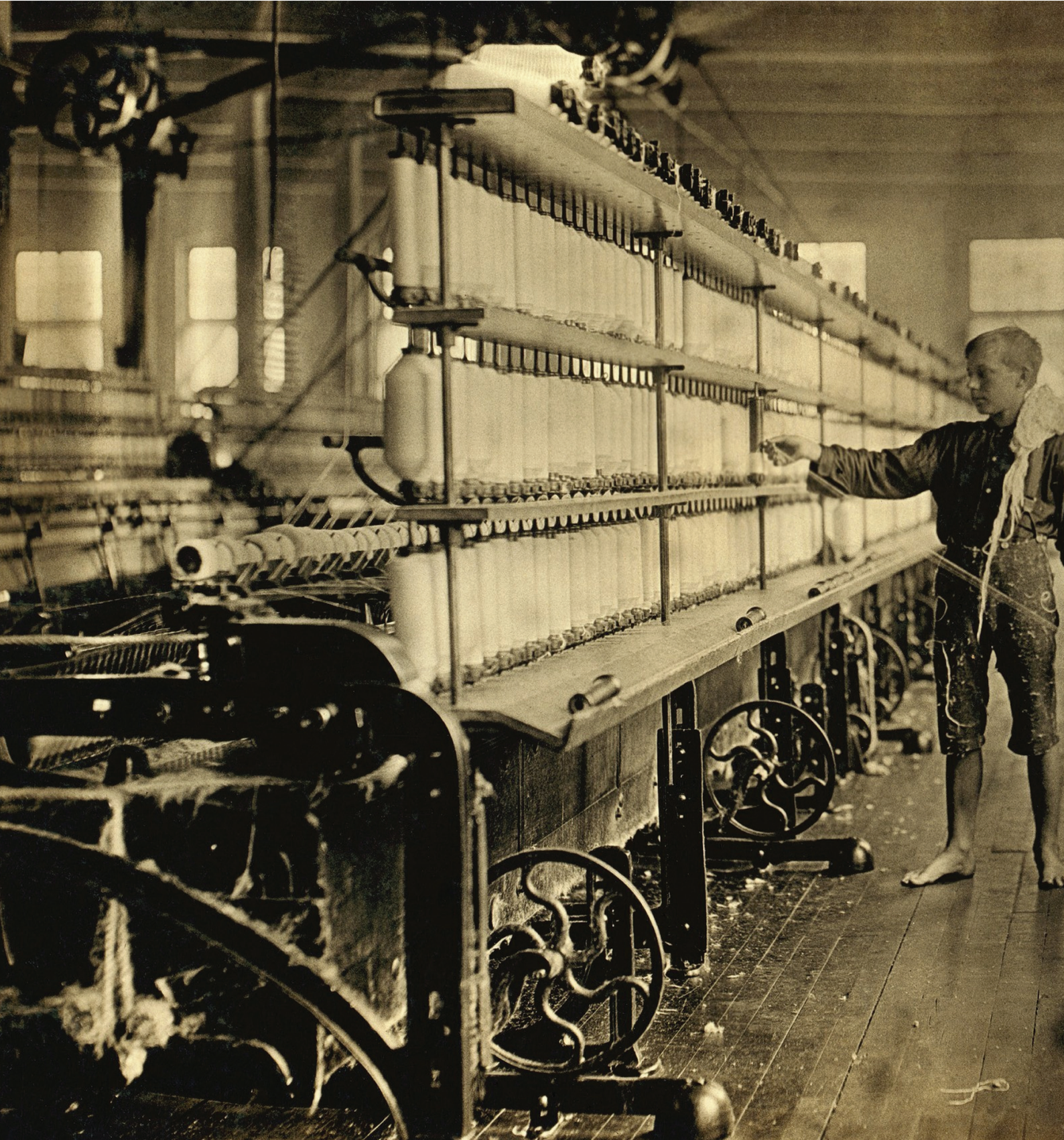



SPOTLIGHT

WILL MACHINES RULE THE WORLD?

THE HUMAN FACTOR IN THE SMART FACTORY

The last person to leave turns out the lights – and then the production hall belongs to the machines. What is actually already happening in some factories is what some think is the future for automated production: completely machine-controlled factories in which humans are superfluous. However, the reality of Industry 4.0 does not reflect this scenario. Yes, production will change. And with it, job profiles will change too. Automation, but most of all software, will play an even more important role. As we humans will too. We will do what we have been doing for centuries – we will evolve. And we will play on our strengths: intelligence, creativity and social thinking.

SMART FACTORY: KNOWLEDGE BRINGS SUCCESS

Industry 4.0 ties into a sequence of revolutions, but comes into play much more subtly. No new revolution, rather an easy-going evolution, but with the power to change many things. Such as the rules, for example. It is no longer just the right manual operation that counts, but the right decision. A look back:

Clever use of energy and the first programming of machines rang in the first industrial revolution. James Watt developed the steam engine, the symbol of industrialization, to technical maturity. Adam Smith spoke of the wealth of nations through the division of labor. And Joseph-Marie Jacquard developed a loom that independently weaved materials on the basis of punch cards. People in Europe were not unanimously enthusiastic. Weavers feared for their jobs and became the first machine saboteurs. The consequence was that the expertise moved from Europe to America. And with it, a number of competitive advantages, opportunities and also jobs.

When electric current, assembly lines and chronometers brought movement into production, the second industrial revolution started. Mass production on the basis of the division of labor became a success model. However, the relationship of man to machine remained unregulated and tense. Routines and going by the motto “once learned, never forgotten” were given more weight than creativity and new paths. Tradesmen and guilds became significantly less important; workers formed a separate class. Specialized in certain production processes, they were, depending on the point of view, seen as servants or masters of the machines. Many traditional jobs disappeared – and many new ones were created.

In the 20th century, an element that had always been part of the first industrial revolution, albeit playing second fiddle to the hardware machine, came to the fore: Monsieur Jacquard’s punch card. Refined into software, it allowed programmable logic controllers, process visualizations and automated analysis, including reporting. Together with the networking of computers and machines, it accelerated the third industrial revolution: digital automation. The relationship of man and machine thus became more clear. Humans controlled machines that performed automated processes. Trained employees and specialists were on the rise. A number of new jobs, such as mechatronics engineers, changed the working world.

Industry 4.0 is, in comparison to the three industrial revolutions, more organized and quieter. In Germany, it is declared by committees as a future plan; in the USA it is understood as part of the Internet of Things. Lights-out factories are considered by some to be their forerunners. In these factories, there are only machines at work; humans

are no longer needed as operators and the lights can be turned off. And this is good: watching a machine at work is not challenging for people. Our job is to be creative, to think outside of the box and to combine logic with intuition and social intelligence. Industry 4.0 will change our working world. However, we decide where the development goes; we design it. The lights-out factories of today are just a particularly well-developed area of Industry 3.0 – they don’t have much to do with Smart Factories.

Anyone who sees a Smart Factory as just a perfectly automated factory is, in doing so, missing the trend and the future of production. This is because the Smart Factory is based on a paradigm shift: it is not just a matter of better, quicker, more efficient machines. It is not merely about hardware and not about more sophisticated software. It is about communication, creativity and knowledge. It is about properties that are deeply human.

DOES INDUSTRY 4.0 TAKE JOBS AWAY OR PROVIDE THEM?

Both. Any change has effects on the status quo. When book printing was invented, it became difficult for scribes. Not nice for scribes, but very good for book printers – and the readers. When people started to specialize, when they distributed tasks in a social circle, that is when jobs started to disappear – and new ones were created. Or do you know what a knacker used to do? The Smart Factory will mean that some jobs are in less demand, some in greater demand and some completely new ones will be created.

The German news magazine Spiegel Online¹ wrote a headline about it: “Industry: digitalization is creating hundreds of thousands of new jobs.” and put more fuel on the fire with an article by the occupational researcher Joachim Möller²: Robots create better jobs. In contrast, the German newspaper Die Welt³ declared at the same time that “Machines could threaten 18 million employees.” Who should we believe?

How the roles and tasks of humans change in the Smart Factory also depends on your situation. Heavily-industrialized countries such as Germany must react more proactively to the change. In standardized industry, there are more jobs that can be taken over by software and machines. This does not just affect production. Texts that are concerned with pure facts, for example, can also be accurately created in an automated manner. Just think of stock market reports, football results or annual reports. But both the production of goods and the creation of texts have areas where machines fail; anywhere where decisions are made that cannot be calculated mathematically, where it is a matter of judgment, emotions or values. Areas with a high proportion of service and creative professions will benefit

Overview of industrial revolutions

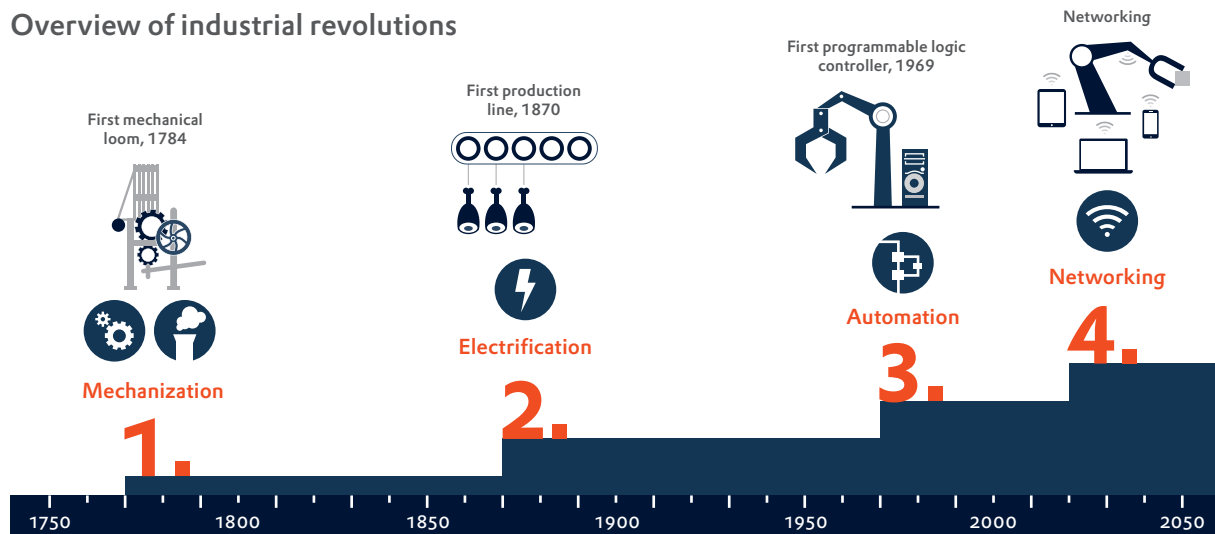

from the change more quickly. And creativity is certainly also technical creativity.

The German Fraunhofer IAO, as a result of a study⁴ that it carried out together with BITKOM, the digital association of Germany, sees Industry 4.0 as an engine of growth for several industries in Germany. It expects productivity increases amounting to 78 billion euros by 2025 in important industries such as car manufacturing, mechanical engineering and equipment manufacturing, electrical equipment, the chemical industry, information and communication technology, and also agriculture. The study anticipates that Industry 4.0 will bring new, innovative products and services, as well as increased efficiency in company processes – throughout the complete value-added chain. Quote: “Industry 4.0 should by no means be limited to the mere deployment of technology. The blanket coverage of IT and smart objects in production processes means that the complete ‘ecosystem’ needs to be considered, i.e. technology, humans and the organization.”

We are still primarily looking at technology when we talk of Industry 4.0. And much already appears to be clear there. Standards are being developed, technologies adjusted. However, it will only work if the human factor is moved to the forefront. If, as part of the Smart Factory, items are able to communicate with machines, and equipment can communicate with suppliers, jobs will also change. The more complex technical linking becomes, the more flexible and willing to make decisions we need to be. We will need less people senselessly watching over a machine and ensuring that the same data always ends up in the same place for evaluation. It is no longer a case of operating switches. We will have to be able to make decisions spontaneously.

Occupational researcher Joachim Möller also predicts in his article on Spiegel Online a growth of qualified employees and a reduction of menial tasks. We will no longer need people to ensure that machine-to-machine communication is deployed effectively; the human-to-machine communication will work significantly better, simpler and more intelligently. People will develop new ideas, new methods and new systems. The more uniform, monotonous and standardized an activity is, the more likely it is that it will be taken over by machines and software.

So the objective cannot be to retain jobs that are not challenging enough, but to promote the qualifications for new tasks. The example of weavers in Industry 1.0 shows that if new methods are suppressed, they emigrate, take their knowledge and create new opportunities and positions at other locations. This has not changed since; on the contrary, global networking and digitalization make it easier to work without being bound to any location. This applies to creative solutions most of all.

Work that can be automated will increasingly be taken over by computers and machines in the future. Tasks that require creativity and specialist knowledge will be in greater demand. Our working world will change with Industry 4.0. The requirements of the Smart Factory, in addition to increasing productivity and more service power will create new jobs, as well as new niches and markets that can be tapped as a result of the much smaller batch sizes of the Smart Factory. In short: goodbye warehouse duties, hello process engineering! This is because well-trained engineers, developers and process experts will determine productivity in the future.

Disappearing jobs do not, however, automatically mean just loss. They can create space for new jobs – and for new working models. Industry 4.0 will thus also influence the approach we take to our work-life balance. We will, for example, be able to think about new working time schemes and providing flexibility on the job. The technical change allows us to discover new opportunities and make use of them. Training and qualification are key here.

SMART WORKING

The Smart Factory needs us to shift our knowledge back into the center of focus again. Simple manual operations are a matter for machines. Industry, as we still know it today, will no longer take a standard route of development. The fourth industrial revolution is not just aimed at industry. It also affects other areas in our everyday lives. Let's just think of driverless cars or smart watches, or drones that can smartly swarm, or the increasing number of everyday goods that have their own IP address. Many people are already using services such as Google Now, Siri, Cortana and others. These build on neural networks, link data from a knowledge graph to other sources and thus change our way of researching and learning. Likewise, the Smart Factory will also be determined by communication, deep learning and networking. Knowledge, networked thinking and action makes us fit for the future.

Currently, digital developments are mostly being pushed forward in the USA and in Asia. Europe is often just a spectator. The training systems, which are often still pure training for a job role, will have to adapt to the changed circumstances. That means not only promoting improved independent thinking and action, but also creativity and the courage to forge new paths. The change to the Smart Factory simply needs more than just a few new manual operations for new machines.

What could production in the future look like? Maybe something like this: bright, modular production sites. Robots working among humans. Items providing the recipe for processing themselves and communicating independently with machines. Humans working in a process-orientated manner, throughout disciplines – also making decisions based on transparent information in real time.

Quentin Clark, Chief Technological Officer (CTO) at SAP, described in WIRED, his vision of the future working world, which would work much more “in real time and contextually”. A forecast of the coming cooperation between humans and technology. Software will have so much information about our tasks and situation that we'll be able to get the right information at the right time – automatically. We no longer need to plan and prepare every step ourselves. We are offered all the information that we need, at any time, from the data we have available. Instead of using working time for the organization of information

and file-based knowledge, as well as the comprehensive analysis of raw data, we can now look at strategies and ideas. We're able to get the necessary facts and analyses as soon as we need them. This is how competitiveness is increased at a company level, which in turn is a positive stimulus for the overall economy.

The Smart Factory is based on smart machines that interact with each other independently. And on smart people who design, think ahead, control, and provide direction. A close connection of software algorithms with human abilities and tasks – this is smart working.

LIST OF REFERENCES:

¹ *spiegel.de*. <http://kaywa.me/wtg7U> [German only]

² *spiegel.de*. <http://kaywa.me/U2cjt> [German only]

³ *welt.de*. <http://kaywa.me/UT2VB> [German only]

⁴ *bitkom.org*. <http://kaywa.me/c3uSF> [German only]

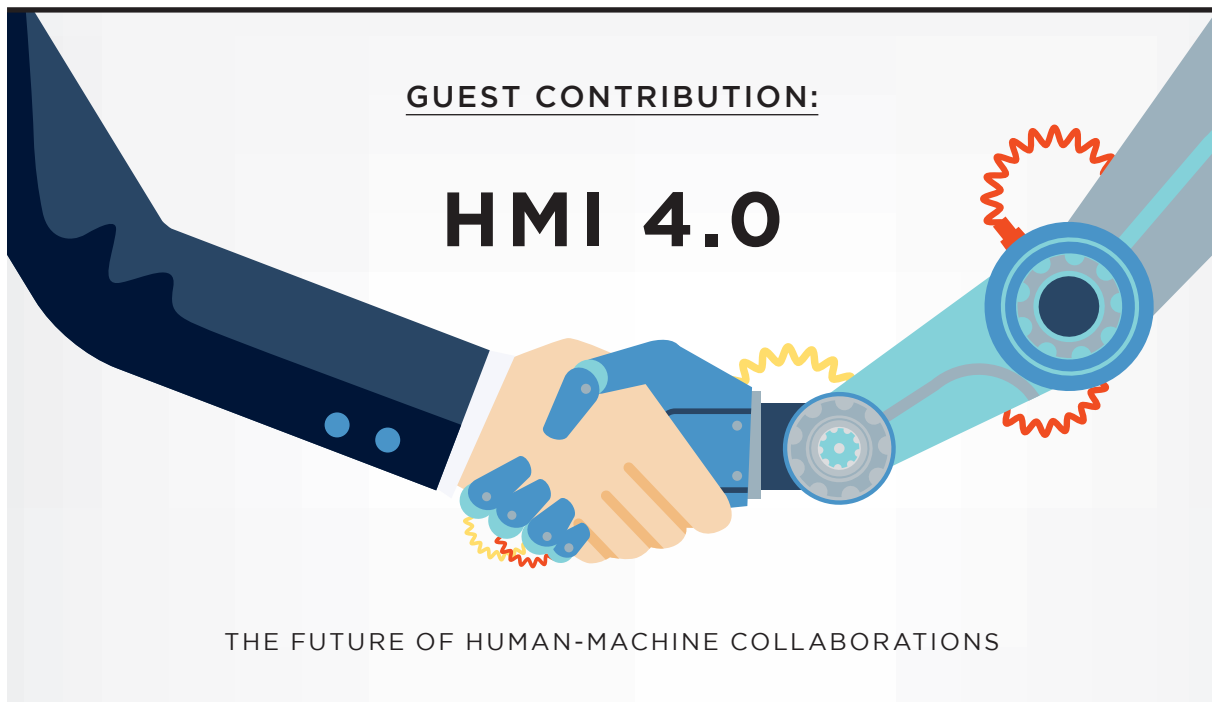

VISION 4.0: INTELLIGENT AND FULLY AUTOMATED?

“Industry 4.0” delights and interests us all. We can see step by step the vision of an intelligent and networked production system become reality. Individual machines connect with each other for coordinated production lines. The networking does not end at company borders. It is thereby ensured that all elements of the value chain are seamlessly intertwined with each other. Intelligent components communicate independently with the instruments and machines in order to receive the correct processing results. Numerous sensors provide continuous information about what is happening. Last but not least, sensor technology is the precondition that allows the intelligent factory to make essential decisions itself and flexibly react to changes in production events. Even individual parts can be manufactured just as quickly and reliably as products from a large-scale production due to the close intermeshing of engineering and production.

Often, the human does not play a role in these future scenarios. The fascination of digital production now seems to lie in the autonomy of the technology which fulfills the highest requirements of efficiency and flexibility without human assistance.

However, from today’s perspective, completely independent production systems which no longer require human intervention and decision-making are neither realistic nor desirable. It is becoming increasingly obvious that the potential of Industry 4.0 can only be fully exploited through a partnership-based interaction between human and machine. Particularly human skills such as creativity and knowledge-transfer for problem solving are irreplaceable in the foreseeable future. The problem

is therefore less about how far the artificial intelligence is taking us towards possible full automation. It is much more about how we can shape the collaboration between human and machine in order to get the biggest benefits out of digitalization.

BROAD RANGE OF TASKS FOR HUMANS

The role of the human in production will change. Particularly routine tasks such as material feed and changeover can be automated. The consistent integration of engineering and production will make several manual steps for configuration of production tools superfluous. The assistance given through automation and networking will collectively lead to an extension of the area of responsibility of each employee. Today, where employees each only attend to a particular machine or a certain technology in the process, in the future they will be able to react flexibly to various events and carry out totally different tasks. This broader range of tasks will also require an extended competence profile. In addition to suitable qualification measures, employees will also require additional technical aids; for example, well-prepared instructions that help master complex or even new situations. Or platforms for knowledge management that support the user to find possible error sources and troubleshooting strategies offered by experienced colleagues.

But not only is the human dependent on machine support. Conversely, the technical possibilities of Industry 4.0 can only be fully utilized through the active input of humans. This not only relates to the engineering performance for the planning, implementation and start-up of intelligent production equipment, also the performance of the employees in the production facility has a big impact.

The human supports many important functions in the Smart Factory. Image Source: Fraunhofer IAO.

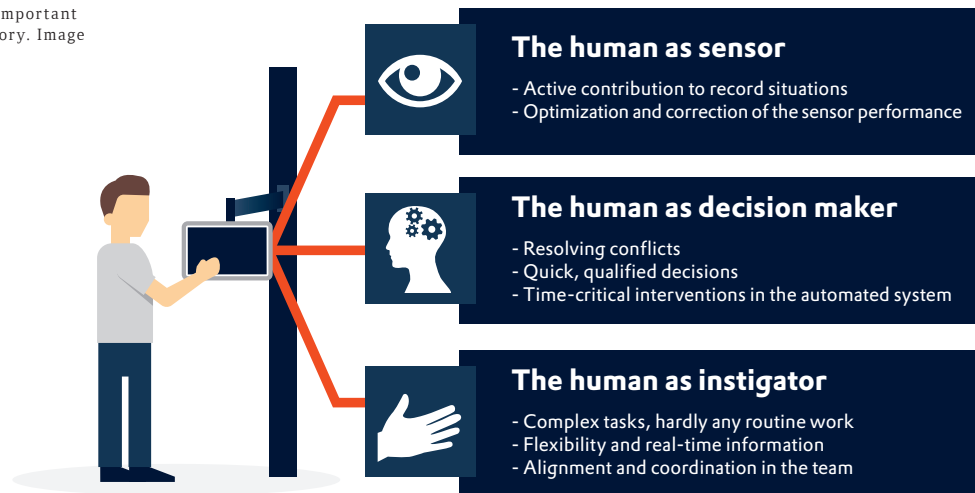

HUMANS AND MACHINES COOPERATE

The important role of the human becomes particularly obvious when taking a closer look at the fundamental information processing functions of the Smart Factory. (1) Perception or sensory system, (2) Cognition including intelligence, decision-making, learning etc. and (3) Action. In all of these three areas, it is worth having a cooperation between the human and the machine. We should therefore see the Smart Factory as a socio-technical system.

1. THE HUMAN AS SENSOR

An essential prerequisite for many Industry 4.0 scenarios is to provide a complete and reliable picture of the production status at any time. Many sensors are employed for automatic recognition of material, location, correct operation, scheduled process steps, etc. Yet sensory systems have limitations: complex information can often only be deduced by integrating numerous sensor sources. A certain degree of uncertainty and error vulnerability remains when distributed sensors are evaluated together.

This is where the human offers a major contribution as a further and particularly intelligent “sensor”. The prerequisite is an effectively designed Human-Machine Interface (HMI), which can offer the production equipment user a suitable visualization of the collected sensor data and displays how the system interprets this data. Users can then confirm or correct this information as needed. They can also add their own observations and further data. Users can thereby effectively support context management and optimize the entire sensor performance.

2. THE HUMAN AS DECISION MAKER

Despite a high level of intelligence and automation the human is still required as decision-maker. This is

particularly the case in those frequent situations which cannot be known in advance or pre-programmed.

In the future, HMIs must be able to efficiently support complex decisions and cooperative decision-making processes. A type of “Management Cockpit” is conceivable that would display not only the current data pool but also give a prognosis on likely events and simulated consequences of possible decision options.

3. THE HUMAN AS INSTIGATOR

The human will actively intervene in the physical processes of production events, particularly in situations where experience and problem-solving competence are required. For knowledge management, the machine can be of support and offer the user at least some of the required knowledge. For example, via instructions and learning aids which are optimally integrated into the task area through Augmented Reality and 3D handling, and object recognition. But the knowledge transfer can also take place in the reverse direction. Through innovative concepts, classic programming and engineering activities can be interlinked with Teach-In mechanisms, in order to connect physical-manual “demonstration” (e.g. traveling distance) with code-based programming. In this way, engineering and production can be integrated entirely intuitively, in order to also support small lot sizes or iterative re-engineering.

SYMBIOSIS BETWEEN HUMANS AND MACHINES

In the three described scenarios, HMI has a very important role. It is becoming clear that future HMIs must support a close cooperation between humans and machines, so that the special skills of man, such as creativity and flexibility, can be optimally complemented with the strengths of

technology, with its assets of reproducibility, accuracy and endurance.

This idea might best be made tangible through the term: symbiosis. Symbiotic human-machine systems support not only hand-in-hand interaction between humans and machines such as in modern human-robot cooperation systems. They are also distinguished by a needs-oriented adaptation of role allocation and responsibilities between humans and machines. Depending on the situation, the initiative, decision-making and action can be taken over to different degrees by humans or machines.

Symbiotic human-machine systems also have advantages when it comes to the scalability of the automation. They offer an excellent approach for the introduction and implementation of Industry 4.0 technologies, especially for small and mid-sized companies. The knowledge which is often in the minds of experienced employees does not need to be formalized in an elaborate engineering process. Symbiotic human-machine interfaces support hybrid production systems by collecting and consolidating existing knowledge during the value-creating processes in order to enable a gradually expanding automation.

OUTLOOK: HMIS FOR MOTIVATION AND GROWTH

Industry 4.0 offers considerable potential for rationalization. Nevertheless, the human factor does not lose importance. The intelligence of the Smart Factory doesn't come from nowhere. And the demand for lifelong learning does not stop with intelligent technology. This is where humans will continually be required in production. Furthermore, we know from research on automation that it is best to keep the human in the loop as much as possible even if humans are only needed in exceptional cases.

Today technology is more than just a tool for the productive human. Current developments are enabling a cooperation – almost on equal footing. An important challenge is to shape the collaboration so that it satisfies both the strengths of humans and those of machines. Most important, however, is that the human retains control and thereby becomes the widely cited “Conductor” of Industry 4.0.

The tasks of the human are thereby changed: fewer actions to perform, more creative problem-solving and more responsibility. Work-to-rule on routine tasks is passé. More demands are placed on the human – as a whole and intellectually. This results in new design areas and challenges for HMIs: how can incentives be established for a high level of user involvement and an identification with corporate goals? How can machines be adapted to individual needs? How can further personal development be supported?

ABOUT THE AUTHOR:

Matthias Peissner (Dr.-Ing., Dipl. Psych.) is head of the Competence Center Human-Computer Interaction at the Fraunhofer Institute for Industrial Engineering (IAO). The interdisciplinary team of engineers, IT specialists, designers and psychologists work on new technologies, methods and design approaches for human-machine interaction. In projects with industrial companies, Fraunhofer IAO develops efficient and ergonomic HMIs for practical application.



Contact details:

E-Mail: matthias.peissner@iao.fraunhofer.de
Tel.: +49 711 970-2311



ABOUT FRAUNHOFER IAO:

The Fraunhofer Institute for Industrial Engineering (IAO) concentrates on current questions and issues around the working person. In particular, the Institute helps companies to recognize the potential in innovative organizational forms, such as cutting-edge information and communication technologies, and supports their adaptation to their individual needs and consistent deployment. The bundling of management and technological capabilities guarantees that economic success, the interests of the employees and the social implications are always on equal footing. Through close cooperation with the Institute of Human Factors and Technology Management (IAT) at the University of Stuttgart, Fraunhofer IAO combines academic research, application-oriented science and economic experience.

You can also find more information at
<https://www.iao.fraunhofer.de/lang-en>.



BACK TO THE FUTURE

A Blast from the zenon Past with COPA-DATA Founder and CEO Thomas Punzenberger

PHOTOGRAPHY: EVATRIFFT.COM

Flux capacitor. Flying cars. Hoverboards. Time travel to the years 1885, 1955 and 2015. Hollywood's famous Back to the Future trilogy brought many technical innovations to screen life. In each of the movies' cinematic time zones, however, the focus remained on human beings and the world in which they live. An approach which COPA-DATA also chooses to work by. For 28 years now, the company from Salzburg, Austria, has been developing ergonomic automation software, with the 1991-released zenon still being very successful today. CEO Thomas Punzenberger takes us on a journey "back to the future", touching on 30 years of industrial automation, before offering a confident look at what's next.

Mr. Punzenberger, you founded COPA-DATA in 1987 in Salzburg. What made you decide to specialize in automation software?

THOMAS PUNZENBERGER: That key realization, actually, happened even earlier. In my previous role as a developer, we pretty much constantly re-invented the wheel and coded everything from scratch. Even then, I wanted to introduce a tool box which would allow engineers to set up their projects without involving a programmer. My suggestion didn't take off though. I understood that because we were not a software company. But it became

in terms of communication and networking opportunities and now we can go and win new markets!

This is also where the Industry 4.0 evolution comes into play, right? To what extent does zenon support the advance from Industry 3.0 to Industry 4.0?

THOMAS PUNZENBERGER: If you read through the specifications of Industry 4.0 you will quite easily spot many of the zenon components there, for example, the modular design or communication options. zenon was not created with tunnel vision in mind; we wanted to build a bridge into

“Ergonomic software – for me that’s software which works and delivers exactly the right kind of data needed at the right time, without me even realizing. It means that I shouldn’t have to keep asking myself if something is working or not.”

THOMAS PUNZENBERGER, CEO, COPA-DATA

the foundation of my idea: I wanted projects to be easy to configure and develop, and I wanted to offer a tool which could help users do the job without coding skills.

This already seems to hint at the “do it your way principle”, doesn’t it?

THOMAS PUNZENBERGER: Exactly. “do it your way”, or also “setting parameters instead of programming”. All these fundamental thoughts originated from that time. My feeling was that programmers could do so much more than just basic stuff. It was crystal clear really: users could work much more effectively if they could only get hold of the right kind of tool box. Everything would be so much easier and more efficient.

Since then, your company has released numerous zenon versions and updates. What are your personal milestones regarding zenon up until now, and why?

THOMAS PUNZENBERGER: I should really start with the first version from 1991 then. Parameterizing was a huge step for us. Another milestone definitely was version 5 with its network options. There were features such as multi-project administration, or multi-hierarchical network structures, or redundancy. The whole network concept is still a highlight of zenon today, even if it was developed more than 15 years ago. From my point of view, our implementation of the soft PLC zenon Logic, or straton, also massively expanded our range of applications. And, of course, the most recent versions starting from zenon 7, with zenon Analyzer and Batch Control. That’s another huge step

other worlds, such as the cloud, SAP or other commercial systems. zenon establishes bi-directional communications, which means we can transfer field data, where we are already savvy with field bus and PLC connections, into the cloud. zenon acts as data host, connector, relay station or, if you like, the brain for everything. Also, there are many intelligent algorithms to compress and process the data. Data reduction is often in great demand these days because only few companies have the required infrastructure to transfer big data from production into a cloud without compressing it first.

Processing data should help both people and companies. Why is it that ergonomics plays such a big part in COPA-DATA’s R&D?

THOMAS PUNZENBERGER: We are continually aware of our main role as developer. In the end, ergonomics is more than just a nice-looking user interface, but a whole software package and the benefits it brings people. Ergonomic software – for me that’s software which works and delivers exactly the right kind of data needed at the right time, without me even realizing. It means that I shouldn’t have to keep asking myself if something is working or not. To give you an example of what we call ergonomics: in our team we have specialists that only look after our software’s usability and advise our developers on design and user interface. Many software providers don’t even invest in this area. Of course, the investment only pays off after a while, but our main goal is that our users just love to work with zenon.

That means that the person is at the center of your software development. To what extent does zenon support its users in avoiding human error?

THOMAS PUNZENBERGER: There are two approaches. First of all, for the users who are creating the zenon projects. For them, the ready-to-use elements in the Editor are of course very helpful. They know what they can expect and what not. Self-programmed scripts would require an extensive quality control. So the pre-defined zenon functions offer more assurance and, most of the

The Fraunhofer Institute for Industrial Engineering, IAO, assigns humans to roles within the future industrial environment (sensor, decision maker, instigator, etc.). How is zenon prepared to meet this development?

THOMAS PUNZENBERGER: Our customers' end users are already creating their individual interfaces. If, for example, user A logs on the system, the temperature is displayed in big font while pressure is shown in small font. At the same time, user B wants to see the engine speed

"I think that the future is bright for users, because they will receive the data they need, regardless of the platform they use."

THOMAS PUNZENBERGER, CEO, COPA-DATA

time, faster performance and improved reliability. We also look at the users who handle the actual machines. Runtime enables a kind of role-based servicing which distinguishes between tasks that can be taken over by everyone and tasks which are restricted to those who have been trained and are savvy. This means certainty for the user but, in the end, also safety for the whole site, the quality of the final product, and so forth.

enlarged on the screen because it gives him more control over the other parameters. This way of customizing has been adopted very well and will definitely be enhanced further. Some users see aggregated data, others direct source data. In the future, this data will definitely be available on many more devices.

Talking of the future: What do you think – what can the young engineer on the magazine cover look forward to in the coming decades?

THOMAS PUNZENBERGER: I think that the future is bright for users, because it will matter much less which platform they use. Regardless of whether they work on their smartphone or tablet or desktop computer, they will receive the data they need. I also think that some topics are here to stay, such as networking, data exchange between devices or even between worlds. We shouldn't forget that for many years automation used to be a kind of parallel universe to the one of commercial IT and computer sciences, and in many companies nothing has changed. That's what Industry 4.0 will try to stop. Let's see if it will succeed.



You have been working in the automation industry for 30 years. What do you think has been a constant issue when it comes to the triangle of machine – software – human?

THOMAS PUNZENBERGER: As an engineer, I want to analyze and display processes as accurately as possible so I can draw valid conclusions from them. It's the same challenge as it was 30 years ago, really, only now we have more technical options and much more information to handle. We started out with about 1,000 tags for our customers' projects in the early 90's. The same customer now hosts about 20,000 tags on one machine. I'm sure the amount of data will continue to explode. Still, our requirements are the same. We want to know what's going on and what we can do to make everything work as seamlessly and efficiently as possible. And that's what we keep working on.

Thank you for the interview.

THIS INTERVIEW WAS
CONDUCTED BY SEBASTIAN
BÄSKEN, PUBLIC RELATIONS
CONSULTANT AT COPA-DATA.







PRODUCTS
&
SERVICES

SERIES: EFFICIENT ENGINEERING WITH ZENON
PART 5/2

Multi-project Administration

In *IU* edition no. 24, we looked at the significant issue of distributed engineering in the zenon Editor. This time, it's all about multi-project administration: the heart of zenon and a feature that none of our competitors' products offer.

TEXT: MARKUS HELBOK,
HEAD OF TECHNOLOGY SERVICES

Multi-project administration covers the capability of the zenon Editor to load several projects at the same time and also the capability to use several projects in Runtime simultaneously. In this article, we will look at both facets and will offer some valuable tips. Let's start with the functions and advantages in the zenon Editor.

MULTI-PROJECT ADMINISTRATION IN THE ZENON EDITOR

In order to use several projects in the Editor, open an existing workspace and select the "Add existing project" command from the main menu or from the context menu of the workspace. This will open a dialog box in which you can see all the zenon projects that are on your PC. You can then add these to the workspace. If you are creating a new project, you have the choice of creating a new workspace or adding the project to the existing workspace. In this way, the workspace is acting simply as a container for the Editor. It has no effect at all on the Runtime. Runtime behavior is determined only by the project structure and by the project that is specified as the start project.

Projects in the workspace can have the following states:

- **Not loaded:** shown as grayed out. The project cannot be edited. It can be loaded to memory and activated using the context menu.
- **Loaded:** shown as black. The project can be edited but is not the active project.
- **Active:** shown in bold. The project is loaded and active. Toolbar actions and wizards generally have an effect on this project.
- **Start project:** shown with a blue border. This status is completely independent of active, inactive or loaded. The project is entered as the start project in zenon6.ini and, accordingly, is started first in Runtime. It is thus possible, for example, to start an integration project in Runtime even though a sub-project is active in the Editor.

TIPS FOR EFFICIENT WORK IN THE EDITOR:

- Create Runtime files for other projects: You can do this either by using the toolbar with the "Create amended RT files for all projects" command or by right-clicking on the project and selecting "Runtime files > Create amended" in the context menu.
- Use the multi-window technology of the zenon Editor: Many windows such as variables, functions, symbols etc. can be uncoupled from the main view. To do this, right-click on the corresponding node in the project tree and select the "open in new window" command. This particularly makes sense for objects that can be moved into screens by dragging and dropping. This method also has the advantage that you do not have

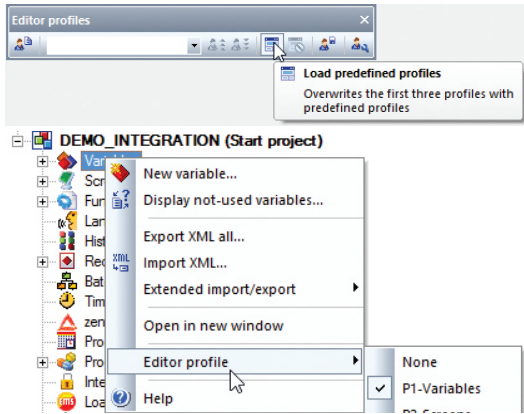

Figure 1: Assigning Editor profiles

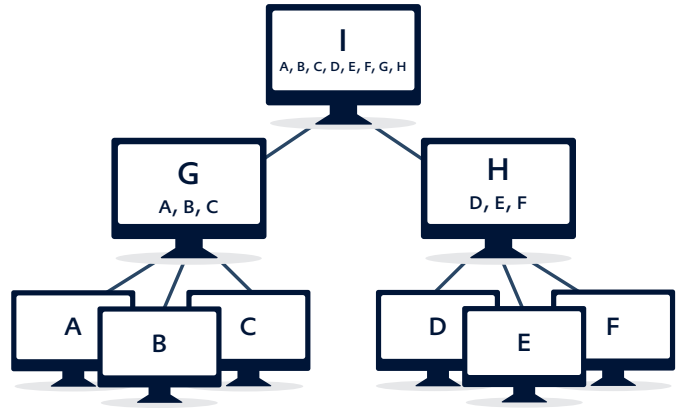

Figure 2: Classic hierarchical network structure

to look for windows in order to reopen them. For example, if you use a two-monitor system you might wish to have lists displayed on the second monitor.

- Use Editor profiles:
 - This makes changing the views child's play. The Editor profiles have two functions:
 1. Saving the window positions in profile sets.
 2. Allocating the profile sets to a node in the project tree. When you click on a node, you get optimally-adjusted Editor settings with different settings for screens than for variables, etc. In the "Editor Profile" toolbar, in the "Load predefined profiles" entry, there is a set of such profiles already saved. You administer the profiles using the toolbar and assign them to the nodes of the project tree using the toolbar (see Figure 1).

MULTI-PROJECT ADMINISTRATION IN ZENON RUNTIME

In Runtime, multi-project capability means that several projects can be loaded at the same time. This works very simply.

In the Editor, you drag and drop a project to a location beneath another one – and you have already connected two projects to one another. You can now, in one project, access the variables, functions, archives, alarms, events, etc. of the other project. You can thus get a comprehensive overview in a decentralized structure. In just one process screen, you could have, for example, the most important variables of all other systems on a monitor, or the temperature and pressure flows of all machines in a trend screen, or all the alarms and events from all the equipment in a hall.

It does not matter whether the projects run on the same computer as the server or two different ones. Also, one project can be a single-user project and the second one a project with redundancy. This is because zenon Runtime loads each project for itself, independently. Therefore, it is not the PC or Runtime running as server or client, only the project has this function. Therefore, on the same machine, you can operate one project as a client and the other as a single-user project, another one as a single-user project and a fourth as a standby. Here are a few examples of how it works in practice.

CLASSIC HIERARCHICAL STRUCTURE

At the lowest level, there are servers A-F and at the mid-level there are two machines that have a mixed role. They are the client for projects A-F and the servers for the independent projects G-H. In addition, the top machine I is a multi-client for all projects A-H and also has a local project running (I) which is defined as a single-user project. This uppermost project is nominated in the zenon integration project (I project) or alternatively the main project. It is the project that must be set as the start project. (see Figure 2)

This model can be transferred to any production site without problems: at the lowest level, there are the production machines. These act as a server. If there are machines from different manufacturers or different versions of zenon in use, this is not a problem thanks to the backward compatibility of zenon. You can still network the machines to one another. The second level could be, for example, the control-panel level in a supervisor's office or used by a maintenance team. The third level could be a client used by production management which provides an overview of everything.

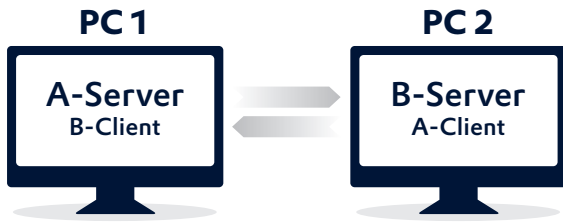

Figure 3: Horizontal transparency

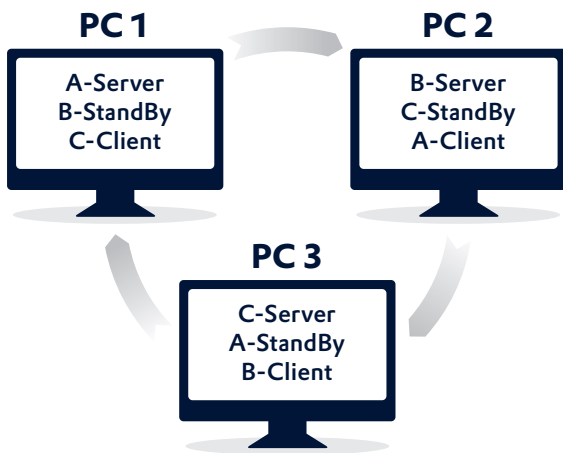

Figure 4: Horizontal transparency with circular redundancy

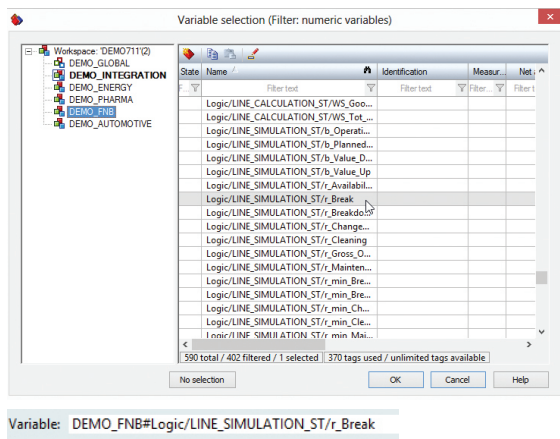

Figure 5: The variable selection dialog with variable selection from a different project

HORIZONTAL TRANSPARENCY

Here, Project A runs on PC 1 as a server and Project B runs as a client; on PC 2, Project A runs as a client and B runs as a server. You can thus see all screens on both machines. (see Figure 3)

EXPANSION TO CIRCULAR REDUNDANCY

With zenon, it is possible to run three redundant projects on only three computers, instead of the usual six. In doing so, Project A runs on PC 1 as a server and Project B runs as a standby. On PC 2, Project B runs as a server and Project C runs as a standby, with PC 3 closing the circle: it is the server for Project C and standby for A. It is also possible to connect horizontal transparency with circular redundancy. Projects A, B and C run on all three PCs. Once as a server, once as a standby and once as a client. (see Figure 4)

Your advantages: you can access everything from everywhere and there is no loss of data in the event of a PC failure due to zenon's seamless redundancy. Two PCs bear the load of three projects; all information is secured. Even attached clients can continue to access the server without problems.

Keyword Client: using circular redundancy, you can create a multi-client to sit at the top if required, which then becomes the client of all projects. Clients always attach to the active server automatically. You know which is currently the client, server or standby through the corresponding system driver variable.

There are no defined limits to the number of projects that can be nested in this way. Limitations will only arise from memory needs, performance, network load, etc. With the right specification, running 200 or 300 projects is not a problem. In internal tests at COPA-DATA, there have been projects running without problems for months with around a million variables.

OTHER TIPS & TRICKS

If you have nested projects into one another in the Editor using drag and drop, you can easily access the variables, functions, screens, archives, etc. of the other projects: either drag and drop into a screen or transfer using the classic selection dialog. All loaded projects are offered there (see Figure 5). In the project itself, objects from other projects are always specially marked: Projectname#Objectname.

The Alarm Message List (AML) and Chronological Event List (CEL) offer another special feature: in these two lists, you can amend the filter so that you can filter all projects in the project structure. There is a separate "Projects" tab for this (see Figure 6).

There are no limits to access in Runtime: you can access sub-projects, overlaid projects or projects at the same level, as you wish. Caution: in Runtime, any projects from

which you've used variables, functions, etc. across multiple projects must also be loaded. Only in this way can selected objects be accessed. In order for a project to be loaded, it must be in the project structure below the integration project.

USE PROJECTS MULTIPLE TIMES

You can use projects in different structures. To do this, you will need several Editor workspaces. Let's illustrate this with an example.

You have two halls in your factory. In both of these, you only want to see the machines from the respective hall. You create a separate workspace for each hall with one integration project each and the machine projects as sub-projects. However, in the production management office you want to be able to check all machines. To do this, create a third workspace with a third integration project, in which you use the existing projects of halls 1 and 2. This is then very easy in Runtime. Runtime knows which computer is the server for the project and connects to it. It does not matter at all whether the projects are under different integration projects. You have a free choice when nesting.

NETWORKS

In order for multi-project administration to work, you must make the projects multi-project compatible. This configuration is particularly easy: activate the "Network" property › enter server name › done! The server then starts automatically as the server; all other computers are automatically clients.

Note also the "Network topology" tab in the zenon Editor. It is next to the project tree (see Figure 7) and has two functions:

1. The project structure is displayed in a clear overview without sub-nodes. You can thus set the network properties with ease.
2. Remote Transport ensures that you cannot transfer just one individual project to the target system, but instead the integration project with all sub-projects.

Multi-project administration in zenon is a powerful feature for reproducing decentralized structures. Despite the decentralization, you have full project transparency. Circular redundancy and horizontal transparency ensure a fail-safe operation and a comprehensive overview.

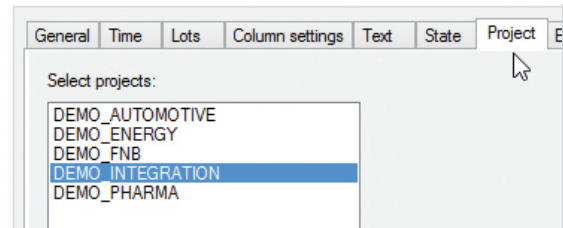

Figure 6: Project selection in AML and CEL

Project name	Network active	Server 1	Server 2
Workspace			
DEMO_INTEGRATION	no		
DEMO_ENERGY	yes	PC1	PC2
DEMO_PHARMA	yes	PC2	PC3
DEMO_FNB	yes	PC3	PC4
DEMO_AUTOMOTIVE	yes	PC4	PC1>

Figure 7: Network topology

MULTI-PROJECT ADMINISTRATION IN THE ZENON NETWORK:

- Activation of the network with two mouse clicks.
- Creation of the multi-project structure using drag and drop.
- Configuration of overview screens by adding variables, functions, screens, archives etc. from other projects.
- Filtering for the alarms and events of sub-projects.
- Distinction between network and local for internal drivers, system drivers, scripts, VBA/VSTA, Process Gateway and zenon Logic.

HOW YOU SECURE YOUR SMART FACTORY BY DESIGN!

The Smart Factory has been inspiring Industry for some time. Plant managers hope for more intuitive operation and a better supply of information, and process managers expect machines that communicate smartly with one another, and look forward to increasing efficiency. This inspiration has the potential to fundamentally change many areas of industrial production. Today, however, one thing is clear: we will not be given the efficiency gains from the Smart Factory on a plate!

This is because, in addition to the high investment required in Smart Factory solutions, we will also be taking on an element of risk – the risk of leaving a known path and placing ourselves in front of new challenges.

In our last edition of *IU (Information Unlimited magazine no. 27, April 2015)*, we highlighted the potential dangers of a Smart Factory from the perspective of industrial security. The opening up of production networks and the exchange of data beyond different areas, and possibly the limits of the company, leaves the automation infrastructure open to attack. In addition to the existing mantra of high availability, automation systems must now implement a further challenge in the shortest time possible: protection of the system against cyber-attacks.

For COPA-DATA, the topic of industrial security has been an integral part of our product philosophy for many years. This stance covers the design of our internal development processes through the architecture of our products to the basic technologies used and operating systems supported. Our aim is to strengthen the zenon Product Family even further and to give our users all the tools necessary to protect their equipment.

As we do so, the following question arises: what can a component supplier such as COPA-DATA contribute to a security concept for a complete plant? One could argue that it is the task of the equipment operators to implement suitable measures to guarantee the security of equipment. However, we believe a holistic consideration of systems, as well as people and processes, is always necessary for security questions. Particular components used, such as software, can make their contribution to “system security”. What follows is an overview, based on questions that our customers have asked.

SECURITY Q&A

HOW SECURE IS MY PRODUCTION NETWORK WITH ZENON?

zenon pursues the approach of “Security by Design”. This means that zenon and its components are already designed for secure operation in the design phase. Nevertheless, the corresponding configuration is necessary for such a complex system. This includes means for the encryption of network traffic, client authentication and many other technical options, such as creating “islands” or a distributed zenon network.

WHAT DOES “SECURITY BY DESIGN” MEAN FOR COPA-DATA?

At COPA-DATA, “Security by Design” covers not only our products but all areas of the company. It is a basic tenet of our philosophy to create high-quality products that are as secure as possible. COPA-DATA thus has its own development team at its headquarters in Salzburg, where the planning and complete project and quality management take place. All product source code is developed, tested and released from the COPA-DATA headquarters. Neither third-party systems nor third-party source code is used in our products. Only this way can we guarantee the high quality of the zenon Product Family.

We are aware that, in the security area especially, we need to work with external experts. This cooperation covers conventional employee training through to targeted security tests and audits of the finished products. Our most important partners are universities, TÜV SÜD and public institutions such as CERT.

To supplement our organizational capabilities, we consistently leverage the most current technologies available. In addition to development and QA tools, for us this primarily includes the fastest support for the latest Microsoft operating systems (currently Windows 10) covering security and batch mechanisms through to Windows error reporting.

We follow a “Security in Depth” strategy. This means your complete production structure can be designed to allow the quick and easy distribution of our HMI/SCADA systems. This way, individual tasks or access to different hardware systems can be distributed. Attackers must overcome a number of barriers before they can get to the core productive system. In addition, there is consistent use of encryption and signing technology in all our products and components.

The overall strategy is topped off with open dialogue and documentation about security. We offer close cooperation with our customers and partners to strengthen security

guidelines and share our experiences in the field of industrial security.

HOW CAN ZENON PREVENT UNAUTHORIZED USERS OPERATING MY EQUIPMENT?

Since its first generation, zenon has included integrated user administration. This function has been continually enhanced and now offers a number of possibilities for application. All user operations can be locked, even access to Windows Desktop and thus access to other applications can be prevented. In addition to the user administration integrated into zenon, there is also the possibility to seamlessly integrate Windows domain users in all products. zenon thus integrates perfectly into a centrally-administered and centrally-monitored user infrastructure. All passwords and user information are, of course, stored in encrypted form in the whole system and also transferred in encrypted form within the zenon network.

HOW DOES ZENON SECURE INFORMATION THAT IS SENT OVER THE NETWORK?

In principle, we use COPA-DATA’s own network protocol to communicate between the individual zenon products. This is characterized by high performance and the security features that have already been integrated. All data is transferred to separate binary data packages and machine-readable information in plain text is never communicated in the complete communication concept; data packages are always encrypted. In addition, users can decide to use strong encryption via the protocol. Further client authentication at the connection setup stage also prevents access to the zenon network.

DOES ZENON SECURE MY COMPLETE NETWORK?

A number of different IT systems are usually used in production. This starts at field level with different controllers and smart meters and sensors, covers superordinate control, in which other components such as databases are frequently present, and reaches to the MES level or ERP system level and the components there. It is therefore not sufficient to consider zenon individually; one must take a holistic approach to security. Taking an effective and thorough approach to security means the complete IT system with all its components, protocols, interfaces and access possibilities must be considered.

IS THE COMMUNICATION TO THE PLC ALSO ENCRYPTED?

This depends on the communication protocols used, and also on the PLC hardware used. COPA-DATA develops all native communication protocols itself. Our experts therefore have excellent specialist knowledge of the protocols, interfaces and devices of different manufacturers. Where envisaged in the protocol specification, our drivers support the modern concepts of authentication or certificate handling. Details about this can be found in the respective driver documentation.

WHAT SECURITY STANDARDS DOES ZENON SUPPORT?

There are various standards which relate to industrial security (such as IEC 27001). Most consider the complete IT system, including all components, people and processes. Many prescribe only very general process guidelines, which COPA-DATA naturally meets. The most important elements are documented and proven development processes. Together with employees at TÜV SÜD, we are currently dealing with the IEC 62443 standard, which goes into the specifics of the automation industry in more detail and prescribes more than just general industrial security guidelines (see illustration). In spring 2015, we started a joint project, as part of which we are aiming to achieve company and product certification in accordance with this standard.

CAN AN ATTACKER CHANGE THE ZENON PROGRAM OR PROJECT FILES?

In principle, physical or administrative access to the file system by an unauthorized user is more or less equivalent to the security worst-case scenario. zenon can only protect itself to a limited extent in this case, mostly because fundamental operating system components can be manipulated or destroyed. In accordance with our “Security by Design” strategy, we have implemented the best possible prevention for this.

One of the most important mechanisms is the signing of the COPA-DATA product files. All program files that we have supplied through the official installation medium are monitored by an integrated VeriSign certificate. In this way external security tools, and also zenon itself, can monitor whether the files are genuine. Manipulated files are recognized and the user is informed immediately. The existing setups are of course signed with hash codes and can thus be checked to see if they are genuine.

For your projects and project data, we recommend that projects are protected by a user with a password, in order to prevent access to critical information in the project configuration files or the manipulation of them. In general, a critical examination should take place to examine who gets authorization to amend a project on the productive Runtime system and whether it is necessary to also amend data by means of remote access.

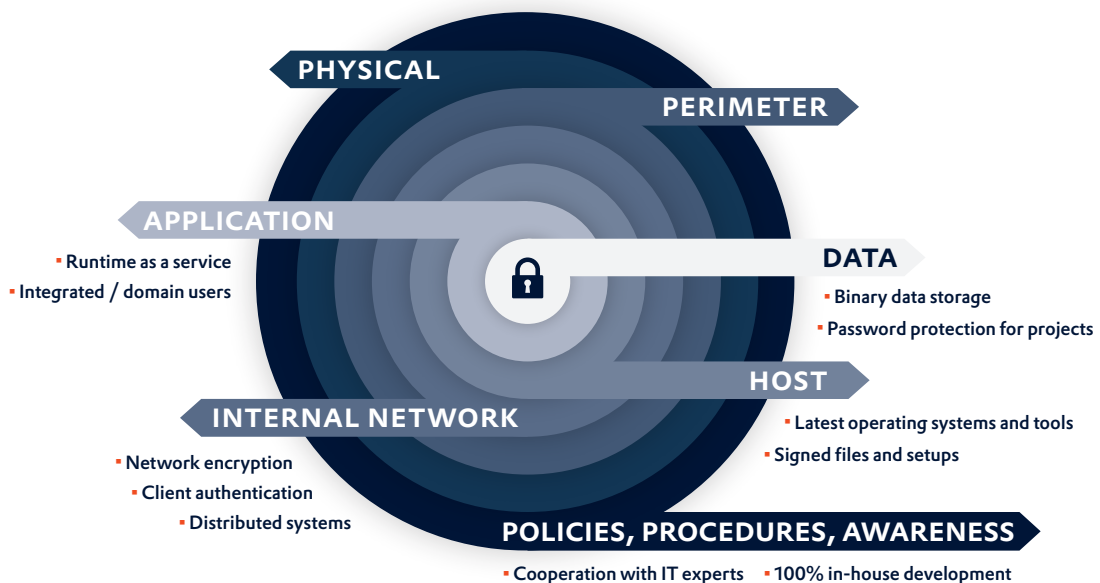

This illustration shows how zenon supports the Defense in Depth strategy of the IEC 62443 standard.

▪ = zenon security precautions

HOW CAN COPA-DATA SUPPORT ME WITH MY SECURITY SETUPS AND REQUIREMENTS?

We have considered security questions for many years. Many ideas and concepts have been incorporated into our products over time. It isn't only zenon's features that contribute to a secure environment. However, it is, most of all, open communication and documentation, cooperation with external expert organizations such as TÜV SÜD, various universities and public institutions such as CERT, which contribute to our continuous improvement. In addition to open dialogue about the subject of security, we also offer our customers specific hardening guidelines for zenon and your IT infrastructure.

REINHARD MAYR,
PRODUCT MANAGER

PHILIPP SCHMIDT,
BRANCH OFFICE MANAGER

Video: No Smart Factory without Security
Scan & Play!

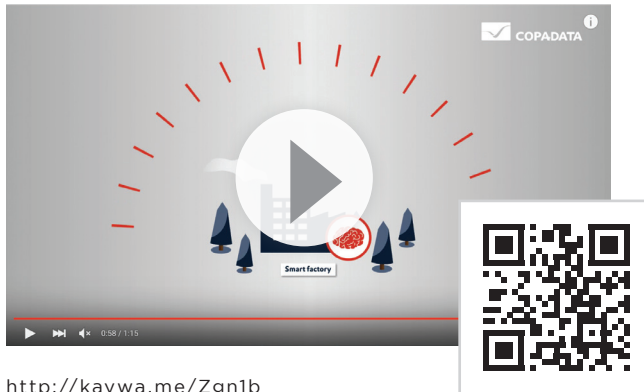

<http://kaywa.me/Zgn1b>

OUR SECURITY TOOLBOX FOR YOU:

- Cooperation with external institutions with security expertise
- 100% in-house development and our own source code / no third-party systems or components / all product expertise in-house
- Security by Design
- Network encryption
- Client authentication
- Distributed systems / "island" creation (Security in Depth strategy)
- Defined and documented interfaces
- File signing using certificates in the program files
- Hash codes for setups / installations
- Password protection for projects
- Integrated user administration
- Integration in the Windows domain user administration by means of Active Directory or AD-LDS connection
- 128-bit network encryption
- Documented and configurable system parameters such as communication ports, user access, etc.
- Additional digital signing of critical user operations
- Secure operation, in order to prevent access to the Windows Desktop
- Operation of Runtime as a service (without desktop interaction) / support for terminal server and thin-client solutions
- Quick support for the latest technologies and operating systems / support for the latest Microsoft patches
- And much more

HTML5: INTERFACE OF THE FUTURE?

A Look Under the Hood

Everyday affairs on the Internet are running smoothly. You want quick access to your account? No problem. Everything happens effortlessly. Errors rarely occur – and then there are the wide range of graphical possibilities. This charm is also subject to machine and process automation. The result: HTML5 as an all-round, worry-free package. But ... wait a minute! Why have I been logged out? Hopefully the process was already carried out ... Have my settings been saved or not? ... There it is now – no, it's not, OF COURSE it can't do it at all ... back to the start.

HTML5, WHERE DO YOU COME FROM?

HTML – Hyper Text Markup Language – is a mark-up language that was developed back when the Internet was invented in order to be able to suitably structure and transmit documents i.e. web pages. The recipient, a web browser, should be able to interpret and display the HTML document accordingly. From the time the Internet was created this simple principle has basically not changed, but it has been properly beefed up.

Mechanisms and standards for adding dynamic elements to web pages through to so-called “web applications” have been developed over the years. Permanent interaction between the web server and client via the network is required. There are software frameworks and libraries galore. The web browser today is a complex system that handles the content received and, in doing so, generally executes complex program code.

A SMOOTH USER INTERFACE THAT QUICKLY GOES IN DEPTH

When we talk of HTML5 today, we mean the technological substructure of such a web application. On the surface, this can be represented by three parts:

- “HTML(5)” still provides the fundamental structure for the web page.
- “SVG” serves for drawing graphics elements.
- “JavaScript” adds dynamic features to the web page and displays corresponding program logic.

But in fact, there are a number of other components that do their bit depending on the requirements of an application: communication, data processing, display, security. The list of tools and approaches could probably be expanded on a weekly basis; the versions on a daily basis. And this for both the web client and the web server. An HTML5 web application is developed within the dynamic environment of current web technologies. It then will continue to exist there too. Much more than just a few lines of JavaScript code are therefore needed.

SOLUTIONS IN AUTOMATION: STANDARDS COUNT

The pictorial model of the iceberg is a good description of the practice of automation: what the user sees as the visualization interface is just a fraction of what the system operation entails. There are many mechanisms at work in the background: obtaining and distributing data from all possible levels, signaling statuses, validating user operations. Reliably and efficiently. An appropriate smart communication principle must be used to regulate the syncing of data. Components from different system generations should ultimately work together as a complete solution. These are the fundamental characteristics of a native automation technology.

And the engineering? The ability to implement standard tasks quickly is mandatory. “Out of the box”, as it is known. This saves time, reduces errors and allows simple reuse of components. This pays off very quickly, particularly for industries with high implementation standards. Once a

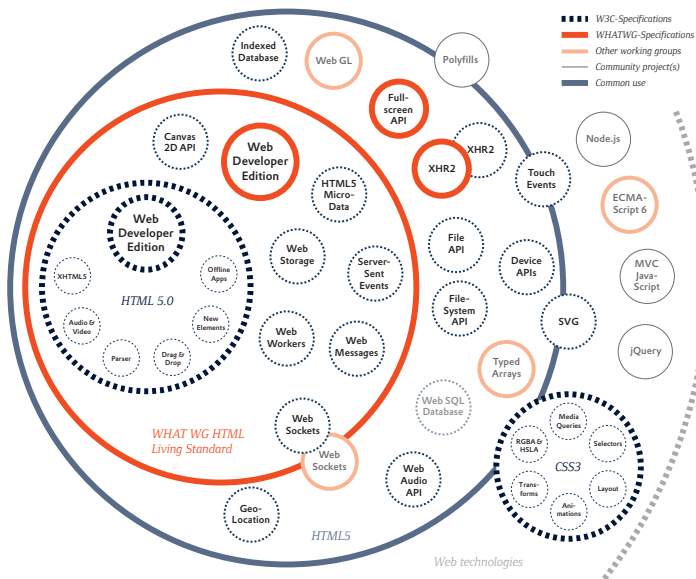

Figure 1: The dynamic HTML5 “eco system”.
Source: “Overview of HTML5 specification” by Peter Kröner. <https://github.com/SirPepe/SpecGraph>. Licensed under CC BY 3.0 DE via Wikimedia Commons.



Figure 2: Simple dashboard example in HTML5 on the basis of the zenon Web Server.

(process) component has been verified, expansions can be handled separately. Progress can be secured on a lasting basis. The close coordination of engineering and runtime components ensures compatibility and reusability. Therefore a change to a different version is also unproblematic. The influence of and dependency on external technology can be kept to a minimum. The complexity is mastered by the system provider. This is also achieved by native automation technology – naturally. Automation experts have their hands and heads free to use their abilities to the full.

USE HTML5 TECHNOLOGY WITH ZENON: EASILY AND AT THE RIGHT PLACE

HTML5 puts information onto the screen – modern and platform-independent. From the user perspective, completely uncomplicated and in the familiar environment; on their own mobile phone or tablet for example. Retrieving process information and enabling selective interaction – the HTML5 visualization is also integrated into zenon according to this principle.

Dynamic HTML5 content can be generated directly from a zenon project. You simply select the screens that should be available in the web. This is how informative dashboards and process overviews are created in no time at all.

In doing so, the process operation behind this is based on proven zenon engineering and runtime technology. First, you use the familiar properties and tools for the visualization design in the zenon Editor. Second, the productive process is reliably portrayed in native zenon technology. The whole range of visualization access can be used flexibly: native zenon client, native zenon web client, zenon Terminal Server, Everywhere Server by zenon. HTML5 visualization acts, to a certain extent, as an “add-on” for your equipment. This makes you feel at ease – not just when it comes to any necessary browser updates or any connection bottlenecks.

This is how you pull the strings when configuring projects and operating your machines and equipment while benefitting from the use of a simple HTML5 front end for easy access to visualization.

HTML5 VISUALIZATION WITH THE ZENON WEB SERVER

From version 7.50 – available from March 2016 – the zenon Web Server can provide visualization as an HTML5-compliant web page. HTML5-compatible web browsers are thereby always in a position to process and display visualization content; regardless of the type of device or operating system. Security has the highest priority of course: measures such as encrypted communication on the basis of security certificates or user authentication contribute to protecting the system.

STEFAN HUFNAGL,
JUNIOR PRODUCT MANAGER

ABOVE THE CLOUDS

Energy Data Management with a Certain Something

TEXT: THOMAS LEHRER,
TECHNICAL PRODUCT MANAGER

The legal requirements for energy management are clear – but technical and organizational hurdles must be overcome for its effective implementation. If you're going to jump those hurdles, why not use the most up-to-date approaches to solutions straight away? Those that go beyond minimum requirements and provide additional savings? With cloud computing, for example.

THE BE-ALL AND END-ALL OF ENERGY EFFICIENCY

Currently only a few topics are as widely discussed as the directive of the European Union to increase energy efficiency. There are a number of solutions which support companies to achieve their energy goals. However, most are limited to the minimum legal requirements for the monitoring and recording of energy consumption and load profiles. This is an option, of course, but not the best one by a long shot. This is because implementing the legal requirements is, at best, just a scratch on the surface. A meaningful evaluation of energy efficiency is only possible if the energy used is also compared to the actual value created. To do this, it is necessary to include production data. Only then is it possible for companies to see how efficiently they really use energy.

ZENON EDMS: ENERGY DATA MANAGEMENT WITH A SYSTEM

When it is a matter of not just somehow managing energy data, but also increasing efficiency and reducing costs, we recommend our zenon Energy Data Management System (EDMS). First of all: it is not an off-the-shelf EDMS, but instead a customized solution package that can be individually adapted to your requirements. It meets the requirements of the TÜV SÜD "Certified Energy Data Management" standard and was certified accordingly. The zenon EDMS thus provides you with optimum support when implementing your ISO 50001 certification too.

A particular advantage of the zenon EDMS is that you do not need any specific hardware for the recording of consumption data. The zenon EDMS adapts to your infrastructure, not the other way round. Integration with

existing systems can even take place during ongoing production. It also supports over 300 communication protocols and interfaces. You can thus include energy data from various sources. Metering points that do not allow automated recording due to their location can be read and recorded manually as offline meters. These meters and the attendant measuring devices are managed and administered in zenon using the specialized Metering Point Administration module.

When setting up the meters and measuring devices, you can set the parameters for recording the data in full. After this, you can flexibly visualize the energy consumption data in the familiar zenon way. Reports and key figures can also be displayed in real time.

High quality evaluation of historical data is another essential function of an effective energy data management system. The reporting software zenon Analyzer, with its enormous variety and flexibility, comes into play here. Reports are not predefined and fixed in zenon Analyzer; they are available as report templates. You can simply amend these with the supplied zenon Analyzer Management Studio. Once you have configured a report template optimally for your requirements, you can derive the report from it. In this way, a number of reports can be created from just one report template, offering many different perspectives on energy consumption: be it for a machine, a production list, the complete operating area or with filtering for batches, shifts and much more. Even the basic zenon EDMS license includes ten report templates with different subject areas for trend reports, load curves, cost evaluations, annual load duration curves and more. As an option, further analyses such as a Sankey diagram, waterfall diagram or OEE analysis are possible. With the zenon EDMS and zenon Analyzer, you no longer only measure and report on energy data, you can also assess it in relation to other recorded values and thus measure productivity or review it against your own key performance indicators. You not only record how much energy you have consumed; you can also evaluate how this energy was used. For example, you can receive key figures detailing how much energy you have used per day, per batch or per item.

You can access these reports at any time using whichever web browser you prefer. You do not need to install a client or a plug-in. You can create the reports required on a cyclical basis automatically and receive them via email.

REPORTS FROM THE CLOUD

If you have decided to introduce an EDMS, you have several possibilities for implementation. EDMS is generally set up locally and embedded into the existing IT infrastructure. Here there will be one-time investment costs in hardware and software, and the ongoing support must be guaranteed. The advantage of this solution is that you have it all in your hands, although the centralization, the cost of investment and the administrative expenses can be disadvantageous, at least initially. Alternatively, you can move parts of the EDMS to the cloud and thus minimize the investment costs and the ongoing support work.

WHY USE CLOUD SERVICES?

The cloud offers some interesting benefits that make moving an energy data management system to the cloud interesting for companies of any size. The advantages are both financial and organizational:

- Low, one-time investment costs
- Location-independent EDMS
- Quick and simple availability

And: it is the ideal solution if you are looking for a system that you can expand flexibly according to your needs. If, for example, production is distributed over several sites, then it does not matter where the energy manager is based. Integration is not significantly different from a local installation. You can implement the cloud solution flexibly, because both zenon and zenon Analyzer offer secure connections to Microsoft Azure.

The following scenarios are possible:

- Data in the cloud; zenon Analyzer local
- zenon Analyzer in the cloud; data local
- Both data and zenon Analyzer in the cloud

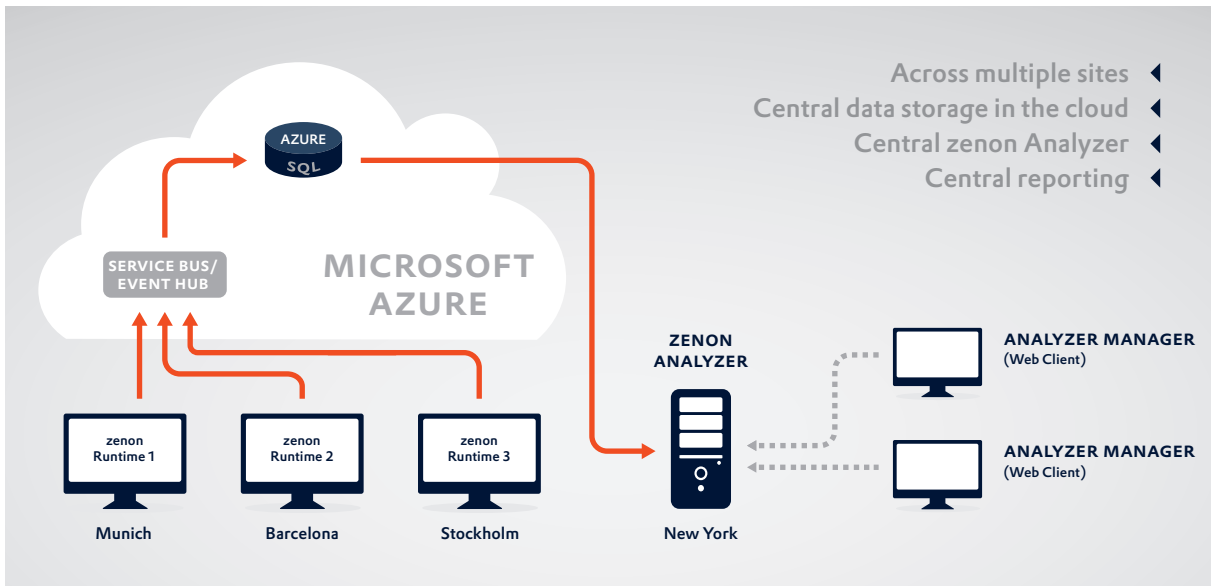

SCENARIO 1: DATA IN THE CLOUD

With this variant, the software components, zenon Operator, zenon Supervisor and zenon Analyzer, are installed locally. The data is stored in the cloud. Energy data is recorded free from error in the LAN and does not depend on the internet connection. Only in the next step is the data stored in the cloud. If the internet connection fails, the data is cached locally until the connection is re-established again. The data that is stored decentrally can be called up from the cloud regardless of location. If the energy manager is not at the same site or if a company has several production sites, this is a decisive organizational advantage. Another plus is that upfront investment costs and running costs are low.

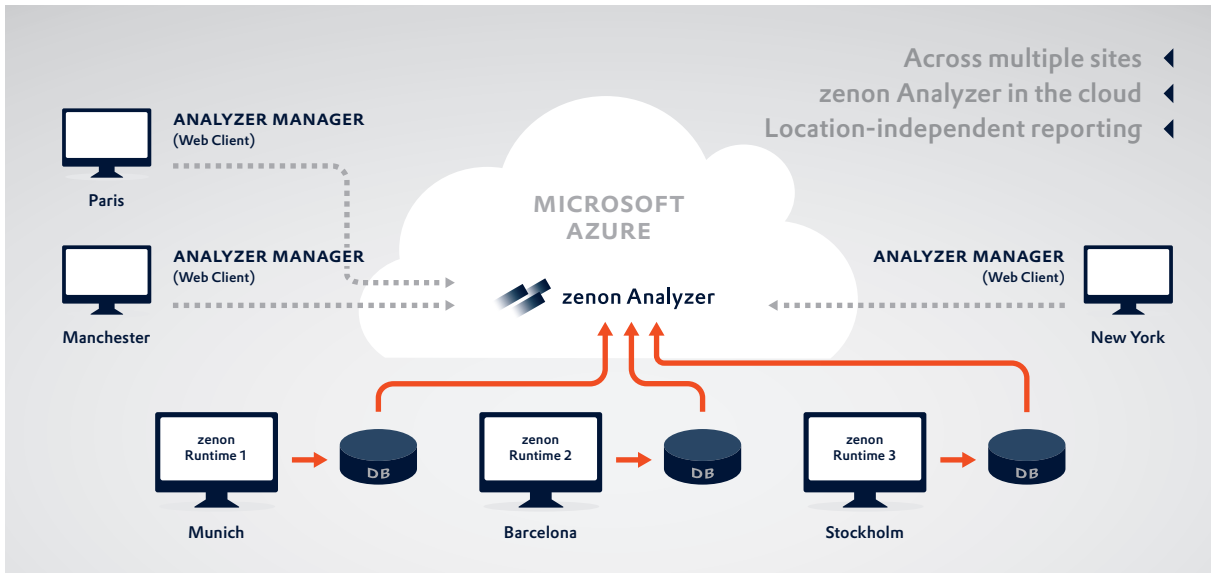

SCENARIO 2: ZENON ANALYZER IN THE CLOUD

In this process, zenon Analyzer is installed in the cloud in full. The data is stored locally on the respective zenon Operator or zenon Supervisor. For reports, zenon Analyzer gets this local data and creates the respective reports. This solution is primarily interesting if there are several production sites that record data independent of one another. The investment costs and running costs are low; the solution can be easily scaled up if required.

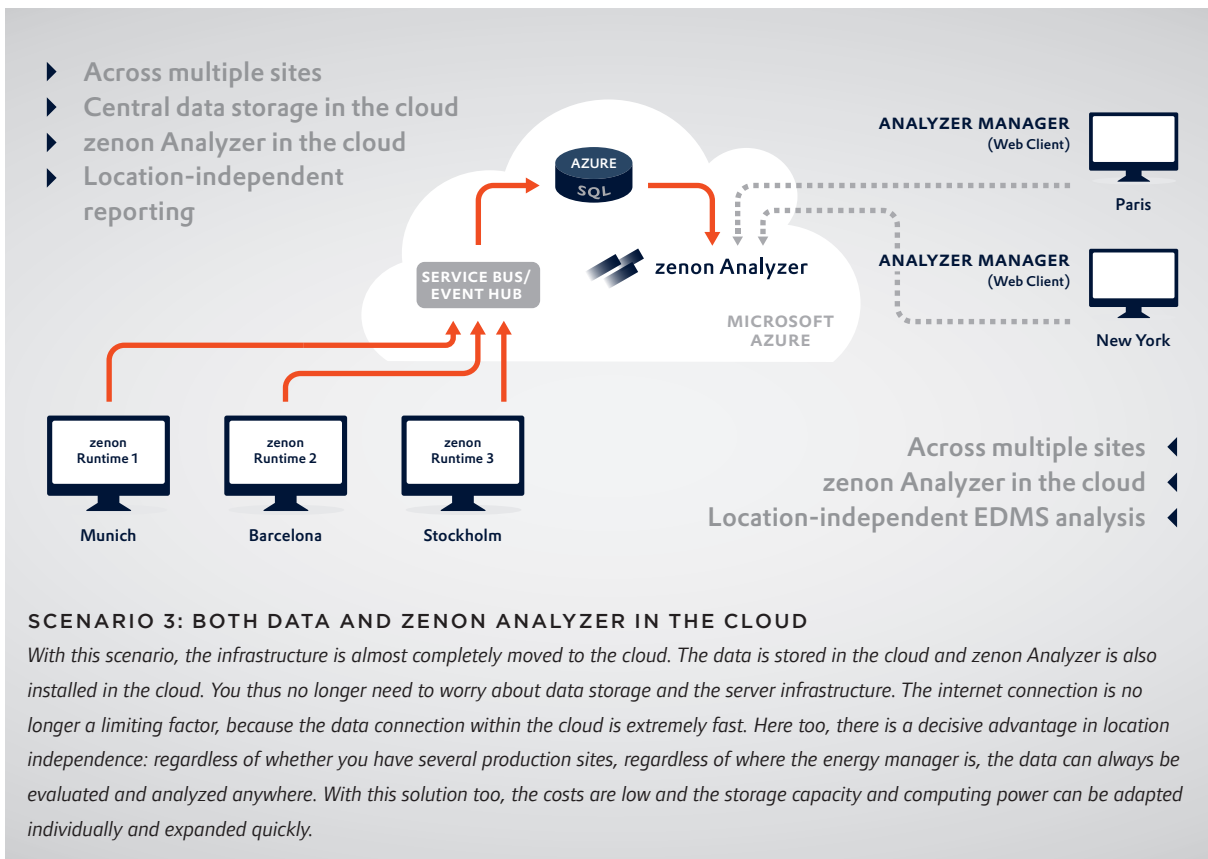

INSECURE CLOUD? DISADVANTAGES AND CONCERNS

As tempting as the implementation of an EDMS solution in the cloud appears, there is some cause for concern. Internet access is absolutely necessary because the service is only available online. The connection should ideally be stable, quick and synchronous.

In addition, the data is outside your own area of responsibility and some companies fear that they can no longer fully monitor it. The access to data also appears to be a weak point if it is transferred using the internet. In addition, data could get into the hands of others or be tampered with through hacker attacks.

However, if we assess these perceived weak points in detail, we understand that data in the cloud is subject to the same risk of attack as data that is stored locally in your own infrastructure. Successful hacker attacks usually are focussed on data that is in local IT infrastructure and not in the cloud. However, as a result of the centralization in datacenters, the danger of an attack is however increased.

Major cloud providers such as Microsoft are aware of this and know that their business model can only work if customers have trust in their products. For this reason, data security is of the utmost importance in Microsoft

Azure. A range of integrated security measures ensure data security in the cloud. The exchange of data to the cloud is in encrypted form. Customers can select the datacenter where they want the data to be stored – there are two in Europe, for example. Microsoft provides more detailed information on the security measures for Azure at <https://azure.microsoft.com/en-us>.

OUTLOOK

The cloud model has passed the start-up phase and established itself worldwide. Most of all, it is small and medium-size companies that can benefit from innovative solutions with the help of the cloud because the cloud removes the need to heavily invest in the setup of a comprehensive infrastructure and staff. The zenon Energy Data Management System is optimally tailored to meet such demands and it is being continually developed. The next version of zenon Analyzer, 3.0, will offer a number of updates such as efficiency class analysis, dynamic normalization of measured data, weather adjustment and much more. Let yourself be amazed!



zenon Supervisor
Independent SCADA System

FOOD & BEVERAGE

- BATCH CONTROL
- RECIPEGROUP MANAGER
- FILLING LINE
- EXTENDED TREND
- REPORT VIEWER
- MACHINE STATUS

PHARMACEUTICAL

- BATCH CONTROL
- RECIPEGROUP MANAGER
- AUDIT TRAIL
- PROCESS
- REPORT VIEWER



INDUSTRIES

&

SOLUTIONS

FOOD & BEVERAGE
ENERGY & INFRASTRUCTURE
AUTOMOTIVE
PHARMACEUTICAL



How Can Your Process Supervision Gain a New Dimension?

3D TECHNOLOGY IN ZENON

Have you enjoyed 3D movies such as *Avatar* or *Jurassic World*? If so, I'm sure you remember how amazing it is to be in the middle of the action. You step inside a fantastic world, with unbelievable creatures so close that you believe that you can almost touch them. The stereo 3D technology offers surprising perspectives and intense emotions. Imagine bringing this perspective and emotion to manufacturing.

At this point, it is far from our intention to speak about "dinosaurs" in the manufacturing world, especially in relation to the dynamic and innovative food and beverage industry. And, certainly, adequate control of all key production processes can help us avoid such intense emotion at work.

It is simply our wish to express the excitement of the COPA-DATA team in meeting different end-users, equipment suppliers and system integrators interested in using 3D technologies. We dedicate this article to all of you ready to discover a new dimension in process supervision.

WHY HMI/SCADA IN 3D?

If you already work with SCADA applications, you will be familiar with two-dimensional visualization or a fixed three-dimensional perspective of equipment. Typically, a system integrator will reduce the process image to only the detail a specific user needs for operation. Often a P&ID drawing is the illustration of the industrial reality for different members of a production team. This is the classic approach which has proven its value over time.

Let's have a closer look at manufacturing roles, be it machine operator, maintenance personnel or process specialist. Their challenges illustrate the answer to our question "why use 3D technology in HMI/SCADA applications?"

These team members might be operating manual valves, checking the condition of the facility, taking material samples, following fluid transfers or replacing spare parts. Such direct contact with the industrial installation makes the effort of a mental correlation between reality and the computer screen always necessary. If one thing can be improved for them, it is the user interface of the control system. What can truly help extend the classic two-dimensional process view? The essential issue is not whether to wear 3D glasses or not, but how to get a better spatial context. What drives project integration is improving the clarity of the display, communicating everything that happens and localizing events within the production equipment visualization.

For this purpose, two-dimensional visualization might often be the best solution for clearly and rapidly communicating essential process parameters or information. However, there are, inevitably, times when two-dimensional visualization will reach its limits and a three-dimensional image could more clearly communicate essential facts.

"Our reality has three dimensions, so why not make the visualization 3D?" says Alexander Wegmayr, Software Developer at COPA-DATA. He has authored a diploma project on this topic. Alexander continues: "We identified plenty of opportunities 3D visualization offers. Think about

the way you prepare your thoughts in the early project phase: are you mainly interested in achieving a spectacular process image? How can you best represent critical information for fast localization and appropriate intervention? How could the system guide the operator to improve the quality of their work? 3D technology embeds specific ways to reach these goals: user interaction, dynamic use of perspectives, object transparency, colors, and so forth."

Let's take the example of a brewery where many tanks, valves, pumps, other equipment parts and kilometers of pipes create a labyrinth network. Imagine a virtual trip through this world on a computer or tablet screen. The freedom to choose any angle and have a perfect correlation with reality is creating a new type of process supervision.

You can quickly fly around the brewery to see what you need. You are in control of the complete production space. This trip is not just entertaining, but delivers essential knowledge served by request: real-time equipment status, process parameters and performance indicators, product data sheets, operating instructions, etc. 3D visualization guarantees a clear focus on essential information in fully realistic spatial context. The "traveler" in such a complex environment is the industrial user and they can be confident of their every action. Even after minimal learning time, the necessary level of operating performance can be reached.

Practical industrial implementations have already confirmed these advantages. Michael Messerschmidt, Software Business Development Manager at HEITEC AG, COPA-DATA Expert Partner and an experienced user of 3D technology in zenon, provides further details: "A 3D visualization simplifies work on the machine considerably. If, for example, a component in the 3D visualization changes color, the user knows that they must act because a problem has occurred. Thus, they can quickly detect errors. It is also possible that companies enrich the individual components in the 3D visualization with other useful content such as videos, documentation or logbooks, so that the user can quickly determine the root cause. At the same time, the operator, if they want, can provide their knowledge and make further

Figure 1: Easy navigation within the 3D model and clear focus on specific machine parts.

Source: Heitec AG.

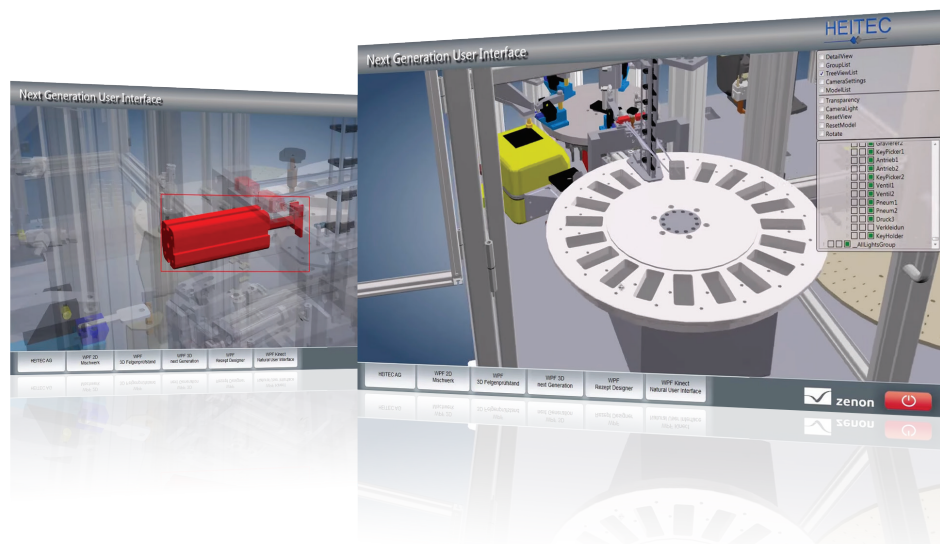

information available. Knowledge can be networked this way. In addition, we also use these 3D visualizations for training sessions. The 3D model is connected with a real control system and the solution is simulated. The training participant can thus practice, learn and work in a real-life environment without blocking a working machine.” – see Figure 1.

The similarities with technological trends such as virtual reality or augmented reality are no coincidence. Powered by zenon, three-dimensional visualization adds a new dimension to your classic process supervision. Let’s see how this works.

3D APPLICATION ENGINEERING WITH ZENON: LESS PROGRAMMING, MORE CREATIVITY

In recent years, we have observed a growing interest in 3D process supervision in the industry. However, how easily you can profit from this innovative technology is inevitably dependent on the costs of the implementation.

The starting point is the 3D model developed by equipment suppliers in the design phase. If available in a graphical file format such as 3DS or DWFX, zenon can automate the next engineering steps for you. It works for greenfield applications, but also for extending an existing process control system with three-dimensional visualization.

Siegfried Neumann, Special Solutions Developer at COPA-DATA, mastered the benefits of the ergonomic 3D technology in zenon by creating a dedicated tool. Siegfried says of his development experiences: *“Using programming languages, any competent software developer has plenty of possibilities to extend zenon’s functionalities. Based on various practical examples, we succeeded with our 3D engineering tool and took a decisive step towards enabling even engineers*

without programming knowledge to use 3D models in zenon. We now offer a high-performance visualization experience, an open user interface and easy integration with various zenon elements. This makes 3D project integration simple and reliable.” – see Figure 2.

At this stage, the 3D engineering tool of zenon is available only for members of the COPA-DATA Partner Community. After loading the 3D model file, you can browse the entire structure of 3D objects and individually configure the integration within your zenon application.

The first spectacular result is the capability for 3D visualization in any screen of the zenon application. This automatically includes user interaction by Multi-Touch, mouse and keyboard. The user can simply rotate, zoom or move around the 3D model of the production equipment. You will intuitively navigate within the three-dimensional production world. Today’s reasonable price point for big Multi-Touch panels makes such an application even more accessible. The system remains extensible for other user interfaces such as Microsoft Kinect, Wii Remote, Leap Motion or 3D mouse.

The 3D engineering tool of zenon offers even more. You can define not only static colors for different pieces of equipment, the color can dynamically change: for instance, depending on active zenon alarms or the type of transferred fluids. The three-dimensional image of a valve, tank or group of pipes can fully reflect the running process in real time.

The operator gains both confidence in taking the appropriate action and a clear focus of attention. The integrator can associate user actions or certain events to predefined “camera positions”. This way, the user gains a new friend: an ‘automatic pilot’ navigating them to the point of interest – see Figure 3. Even for complex equipment, such

Figure 2: The 3D engineering tool in zenon makes integration simple and reliable.

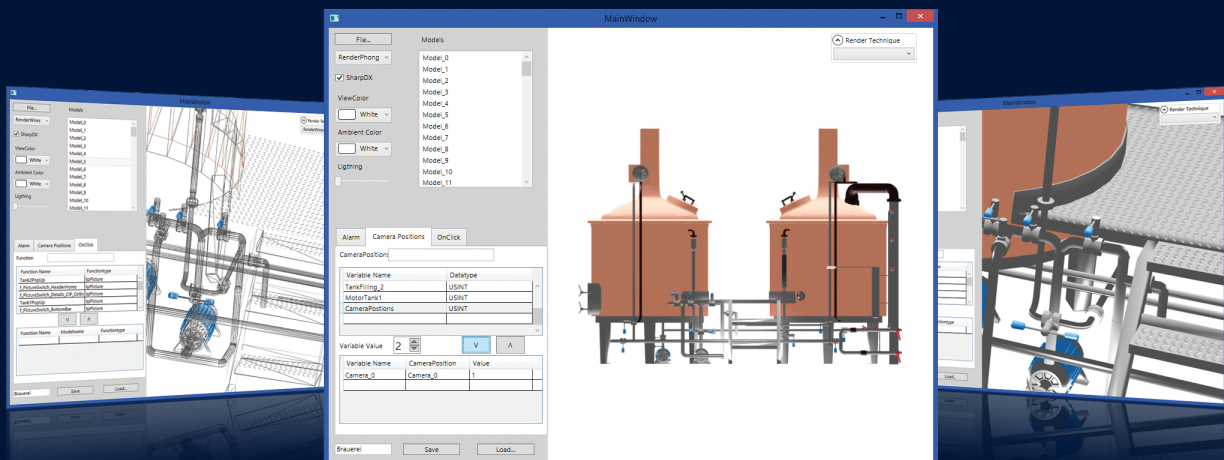

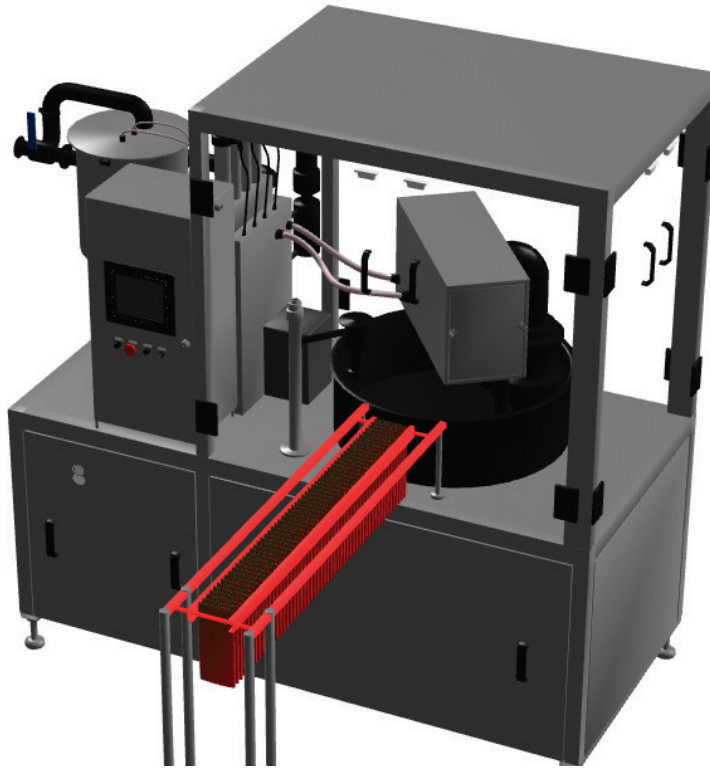

Figure 3: Automatic alarm localization using 3D process supervision.

an intuitive user interface guarantees the essential spatial context needed for maximum precision.

What happens if the equipment complexity is still too great for 3D visualization? zenon's 3D engineering tool enables you to control the visibility and the transparency of a certain group of objects. In doing so, the user's attention can be directed to focus on important equipment parts.

We've already seen how to travel either manually or automatically within the production world and how this can be used to direct focus to a certain piece of equipment. The next technological step is associating zenon functions with specific 3D objects. Thus, the intuitive interaction with the 3D visualization screens becomes just the start of an amazing range of possibilities. For instance, by clicking one machine part, the user might call up a pop-up faceplate showing real time data from a PLC – or, perhaps, information archived in a specific database; maybe technical documentation or spare parts availability. The user can acknowledge an alarm, start a guided manual procedure, type a comment to an event or call a statistics report. Combining different zenon functions with the 3D visualization is a precious source of ideas for new user-centric approaches.

Again, zenon makes the newest technology available for rapid and reliable engineering. Moreover, the system integrator can freely express their creativity by combining the

wide range of out-of-the box and configurable zenon modules. Programming interfaces open even more possibilities.

For production teams, 3D process supervision with zenon broadens the perspective of any application, be it human machine interface, line efficiency, energy data management, maintenance support or utilities and building supervision. 3D visualization helps any user to interact intuitively with the real industrial environment and therefore to manage complexity with less effort.

WE ARE ALWAYS HAPPY TO HEAR ABOUT
YOUR EXPERIENCES WITH ZENON. TELL US
ABOUT HOW YOUR PROCESS SUPERVISION
GAINED NEW DIMENSIONS USING 3D
TECHNOLOGY IN ZENON:
EmilianA@copadata.com.

EMILIAN AXINIA,
INDUSTRY MANAGER
FOOD & BEVERAGE

RENEW A THOUSAND SUBSTATIONS IN JUST TEN YEARS?

IEC 61850: from XML to HMI in a Few Minutes

Grid operators face a difficult task: the secondary systems of more and more substations need to be replaced in ever-shorter intervals. If this isn't done, or it isn't done quickly enough, there is the threat of a blackout. But there is no need to be under time pressure. There is a well thought out standard and a new wizard to take on the job. What used to take days can ideally be completed by engineers in a few minutes.

TEXT: JÜRGEN RESCH,
INDUSTRY MANAGER ENERGY & INFRASTRUCTURE

IT'S ALL DOWN TO THE STANDARD

The IEC 61850 group of standards describes not just a communication mechanism, but also an XML-based configuration language. Many clever applications are possible with this system configuration language (SCL): you can configure and model substations or any desired equipment with it. Based on a top-down approach, a system is first defined roughly and then specified in ever-more detail. The typical route starts with the system specification description (SSD), continues with a system configuration description (SCD) and ends with configured IED descriptions (CID). However, from the perspective of an HMI application, the SSD already contains so much information that complete equipment screens can be generated from it.

In principle, the SSD is a waste product of an initial configuration that describes basic requirements. The primary switching devices are placed in a logical electrical interrelationship; voltage levels, transformers, bus bars and protection functions are defined. In short, SSD is a functional description. Ingenious is that developers have decided that the standard should envisage X and Y coordinates, at least as an option, which are used to set out the position of the

primary switching devices. These are ideal requirements for generating an HMI screen that reproduces the arrangement of the switching devices precisely.

MORE POWER: THE IEC 61850 SSD IMPORT WIZARD

A new zenon Editor expansion tool, the "IEC 61850 SSD Import Wizard", comes into play here. This wizard reads an SSD file and draws a single-line diagram into a zenon screen at the touch of a button. As mentioned, the functions of the primary devices are also described in the SSD file. Furthermore, the wizard knows which element it must draw at the respective point, such as a transformer, circuit breakers, disconnector switch, etc. The person configuring the project can use supplied elements and easily adapt these if required. It is also possible to create your own symbol library in this way.

As a result of this technology, plant operators and integrators have the option to define standards that the wizard takes on directly. The user determines the appearance, properties and color scheme at a central point and simply accepts them into all single-line diagrams.

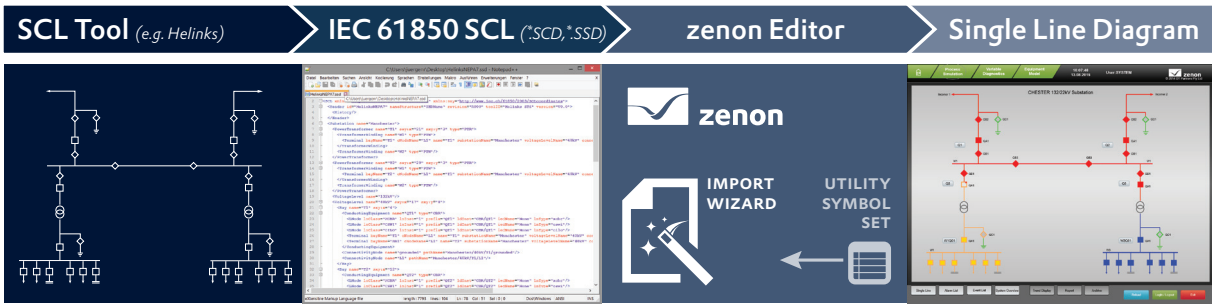

From an SSD file to a single-line diagram

RENEW SECONDARY DEVICES FLEXIBLY

The wizard primarily shows its strengths with the refurbishment of the secondary devices. The life cycles of the secondary devices are getting shorter and shorter. Protective devices used to last 40 years before they had to be replaced, now the lifecycles span 15 to 20 years. With on-site HMI systems, the reduction of the operation lifetime occurs even more quickly. We now measure a cycle of seven-and-a-half to ten years. Calculated across all substations of a large distribution grid operator, this results in quite a large number of refurbishment projects, i.e. projects for which the secondary systems are replaced while the primary systems remain operational. Here, operators must not fall behind with their quota of necessary renewals. Failure to do so could lead to a device failure and could possibly endanger the certainty of supply. The solution requires fast and error-free work with technology that reduces the load for integrators when configuring their project. And what could be better for this than a tool that is incorporated into the IEC 61850 configuration chain and implements the requirements from the description files without errors? It can be so easy...

When configuring a project, you simply select the SSD file, determine the symbol set of the grid operator, define the zenon screen and – go! The wizard automatically draws the single-line diagram. After that, you only need to link the variables to the symbols, make some adjustments here and there and the tailor-made HMI is finished. It does not matter how large, the screen is generated in just a few seconds. The necessary renewal projects can thus be processed in time – or even ahead of schedule. This is in turn reflected in the costs; not just on time but also cheaper.

GIVE TOP-DOWN A CHANCE

Experience shows that the top-down approach of IEC 61850 is not for everyone. Many engineers prefer to initially work from the perspective of the devices and signals. Only then do they configure their interaction and the forwarding of data to the control center of the grid operator.

However, a pre-defined SSD can be advantageous for a party putting something out to tender. Imagine a tender for

a new or existing substation – and the possibilities for the people configuring the project if there is already an SSD file in the tender documentation for the respective substation. The experienced supplier can then simply start the SSD import wizard, and will have the single-line diagram generated automatically and can add it to the tender submission as a screenshot. The party issuing the tender can then immediately see how good their local HMI could look. And the supplier probably only needed five minutes to display their potential in an ideal light.

Renew a thousand substations in just ten years without a rush? It is possible. Just leave the laborious creation of single-line diagrams to a wizard. And you also gain the possibility to set standards, to shine in tender processes and to implement projects more quickly. Your key words: “top-down” and the “IEC 61850 SSD Import Wizard”.

Video: from XML to HMI in a few minutes

Scan & Play!



<http://kaywa.me/1Hp61>

Jernbaneverket Modernizes with Automation Software zenon

NORWEGIAN RAILROAD NETWORK TAKES A FORTY YEAR LEAP FORWARD IN TECHNOLOGY.

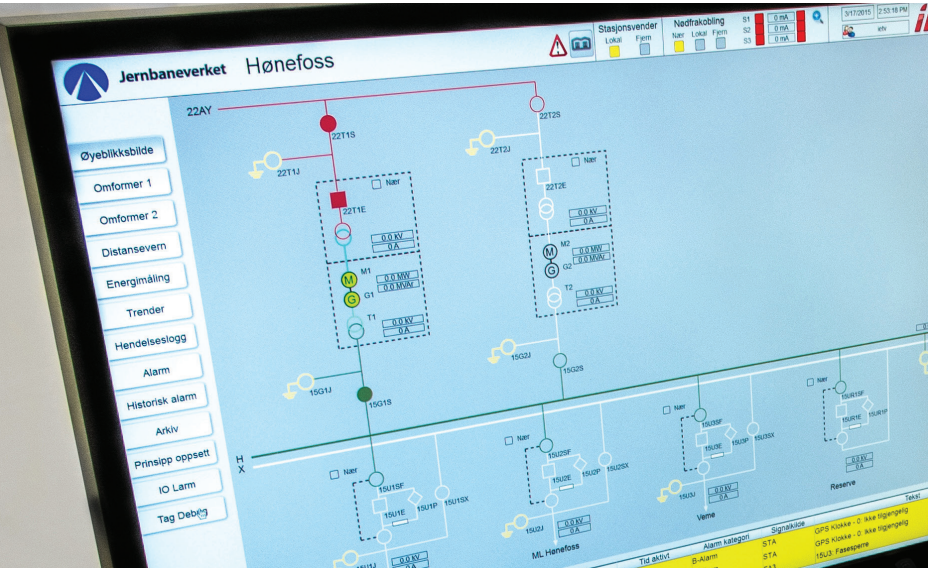

The Norwegian rail travel network operator, Jernbaneverket, decided to perform a major upgrade to its infrastructure in order to modernize rail service delivery and optimize maintenance and performance. The technology for controlling the power transformer stations throughout its nationwide operations was more than forty years old in some areas, so a modern solution for controlling and monitoring these stations was required. The decision was made in favor of zenon, the HMI/SCADA software from COPA-DATA.

A NEW GENERATION

Accomplishing a major reorganization of the technical electrical infrastructure for a national railroad network is by no means an easy task. It operates on its own specific alternating current frequency, and uses numerous existing power transformer stations which are situated throughout the network.

Before any solution could be considered, a thorough analysis of the current infrastructure was required in order to produce a detailed step-by-step plan for the entire upgrade. By upgrading the network's performance, the project will give Jernbaneverket the potential to meet today's requirements and standards. However, the implementation of the whole upgrade operation is complicated by the fact it needs to take place without disrupting the regular train service. A challenge, to say the least.

Much of the technical infrastructure of the network's substations dates back to the sixties and seventies, when the last major change in technology took place. Outdated technology results in poor performance and requires regular attention and maintenance. The fact that this maintenance has to be performed in-situ means that skilled and qualified maintenance staff need to travel to the substations on a regular basis. This travelling takes up time and is not very efficient. Consequently, the costs rise continuously.

A modern solution would result in big improvements in the daily routines for controlling and running the power network, and also add the capability to control every individual electrical substation from the main operational headquarters. Improved safety and a better working environment for the employees are also important factors in the equation.

PILOT PROJECT

Jernbaneverket began by initiating a series of pilot projects. These projects marked the starting point for this huge and complex upgrade to the technology controlling the entire network.

The Swedish System Integrator, IETV, a Qualified Partner of the COPA-DATA Partner Community, was selected for one of the pilot projects. The scope of this pilot was the complete rebuilding of the substation in Lundamo, south of Trondheim. For the project, IETV created a completely new concept for the controlling and monitoring equipment, including all hardware and software solutions. IETV chose zenon, COPA-DATA's control and monitoring software, as the SCADA platform for the concept.

Malin Fridmar, Project Manager at IETV, explains why IETV felt zenon was the best choice for the project: "We chose zenon as the HMI/SCADA because it offers a complete solution for the IEC 61850 protocol, which is vital in this type of application."

GETTING THE TRAIN ROLLING

The pilot project concept took six months to design and deploy. Based on the success of the pilot project, Jernbaneverket selected IETV to rebuild and modernize the controlling and monitoring equipment for sixteen additional electrical substations in its network.

This framework agreement runs until 2020, and production is now progressing at full speed. Every project at each site comprises several steps: first, IETV visits the location to take photos and make notes about the specific installation and requirements for the substation in question. Then, a complete solution for the electronic schema and circuits is designed. When the design is finalized and approved, the metal cases for the electronics can be built, and the complex work of programming every circuit can begin.

A MODERN SOFTWARE SOLUTION

Jernbaneverket chose a solution based on zenon for many reasons. The built-in flexibility is one key reason – since a zenon-based solution is highly scalable; from a simple HMI all the way to a zenon Energy Edition supervisory system. zenon's uniquely open communication is another key benefit. zenon incorporates an Integrated Gateway to the central control stations, with communication over IEC 60870-5-104.

Internal communication inside the substations is handled with Siemens and VAMP relay protection systems over IEC 61850, and also with Beckhoff PLCs via IEC 60870-5-104.

Two further major contributions in favor of the zenon-based platform are the fact that zenon enables IETV to easily create intuitive, modern user interfaces at each location for

the operators, plus zenon's ability to enable the users to adapt their own user interfaces within the parameters of the general solution.

A WORTHY FUTURE PLATFORM

The Lundamo project has been working at full tilt for one year now, and the response from the everyday users of the system is very clear. Jernbaneverket reports that operators and maintenance staff are very satisfied with the entire solution.

A key factor in its success is the vastly improved reliability. An electrical substation does not require increased productivity. Instead, it focuses entirely on reliability over a longer period of time.

The new solution has resulted in a big reduction in the need for reactive maintenance or troubleshooting, since it is now possible to control and operate the substations from the control room at Jernbaneverket's headquarters. Alerts about possible faults or events are acknowledged much earlier in the process too, which makes them far easier to resolve.

A vastly reduced scheduled maintenance program is another important differentiator compared with the old solution. The new zenon-based solution for operating, controlling and monitoring the railroad's power network on a daily basis has proved itself as a reliable platform over the long run. Roland Johansson, Head of Technical Development at IETV is delighted with the success of the project. He says: "zenon has proven itself the perfect solution here. It is a SCADA solution for the entire energy corporation."

ZENON DELIVERS:

- Integrated Gateway over IEC 60870-5-101
- Remote operation from a central control station
- Internal communication over IEC 61850
- Communication with Beckhoff TwinCAT
- Scalability from HMI to SCADA
- Improved reliability
- Reduced operational and maintenance costs

CONTACT:

Olov Emås
 Managing Director, COPA-DATA Scandinavia AB
info.sweden@copadata.com

FROM MACHINE CONSTRUCTION TO EQUIPMENT RAMP-UP

LIFE IN THE FAST LANE WITH ZENON

TEXT: BERND WIMMER,
INDUSTRY MANAGER AUTOMOTIVE

The creation of new production lines or the retooling of existing equipment means enormous project pressure for everyone involved. From construction, through engineering to putting into operation and ramp-up, zenon accompanies you through all phases of the project. The result: more efficient working processes and less stress.

Competitive innovation between car manufacturers leads to a wide variety of models and variants and results in the model cycles becoming shorter. With the introduction of more and more new cars at ever-shorter intervals, the time pressure increases considerably. zenon can make a valuable contribution to optimizing all processes and thus adhering to time-to-market and time-to-volume requirements.

CONSISTENT AND WITH GOOD COMMUNICATION - FROM THE START

Even in the construction phase, good conditions for effective project work can be created with the help of zenon. With over 300 communication protocols, zenon is in a position to process data from all hierarchy levels of automation: from the field level through to the manufacturing robots through to SCADA and MES. As a consistent system, zenon records the data only once and thus guarantees its consistency during further processing for different applications.

Interfaces can also be used to integrate other systems with an open interface. Users can thus, for example simulate equipment components or even complete plants, using connected, external software with zenon as the "gateway". With constructed forecasts, manufacturers can optimize their complete system at an early stage, avoid bottlenecks and determine potential causes of delays.

INDEPENDENCE CREATES FLEXIBILITY

zenon is independent of the respective hardware. A switch to a controller or a panel or changes to the IT infrastructure are thus easy to carry out. If there are supply bottlenecks

with panels, for example, the type of panel or even the supplier can be changed without losing time. zenon automatically amends the displayed HMI/SCADA screens in the selected screen resolution.

All interfaces required for engineering are already defined in the construction phase. zenon thus inserts itself optimally into the existing infrastructure setup. The projects remain flexible so changes can be implemented at any time. As a result of this, pressure on the project is minimized considerably and milestones can be reached on time.

CONFIGURE PROJECTS EFFICIENTLY

When engineering equipment, the project teams involved usually work in parallel. Effective tools that provide quick, error-free results are essential in this phase. The zenon Editor supports people working on the project optimally to create the required HMI and SCADA user interfaces. In doing so, many standardization methods are used, such as HMI/SCADA components from predefined building blocks. The person configuring the project can rely on tried and previously tested objects to achieve the desired results faster and at less cost.

GENERATE PROJECTS AUTOMATICALLY

For quicker project configuration, a project generator is also available for engineering teams. This interprets data sources such as equipment descriptions, lists or PLC programs and uses defined rules to automatically create the corresponding zenon projects. In practice, this means up to

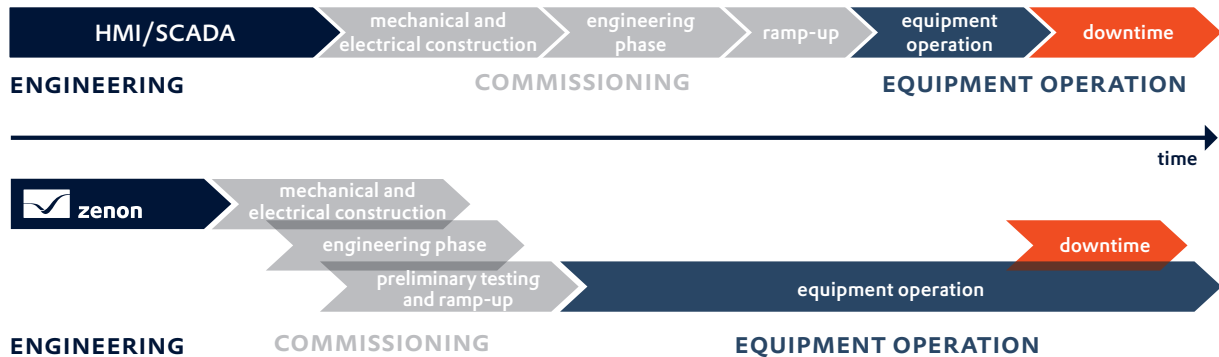

Reduce life-cycle costs and total cost of ownership with zenon.

98% less configuration time is required – with a degree of automation of 80 to 90%. The advantages: the frequency of errors and costs are reduced and the experts have more time for more-demanding work.

OPTIMUM PREPARATION

In the zenon Editor, several specialists can work on a project at the same time across the network, configuring complex equipment on a central project server.

The driver simulation integrated into zenon also allows advance tests of the HMI/SCADA projects. For example, it is possible to test a controller that is not yet available on the network. The managers of the equipment test and optimize the operating screens, actions and messages in advance and prepare the user interface optimally for its subsequent use on-site.

EASY COMMISSIONING

In addition to the best possible preparation, the stable runtime behavior of zenon also ensures that putting the project into live operation is as relaxed and risk-free as possible – even under difficult conditions such as network failures or power cuts. The ergonomic Editor allows the quick execution of temporary expansions and thus makes commissioning easier. This also includes the installation of additional clients for the monitoring of the systems. Clients can also be run on mobile devices, so that the data can be available precisely where it is needed.

KNOW WHAT IS HAPPENING

With the zenon Alarm Message List, the sources of problems can be easily identified. Thanks to import functions, alarms can be transferred from the subsystems in advance. This avoids duplicate administration of alarm text data. The alarms that have been created are then processed accordingly. Filtering and sorting mechanisms aid analysis and allow flexible reactions to current situations. Individual alarm groups can be deactivated on a temporary basis in order to preclude parts of the equipment that have not yet been completed.

QUICK RAMP-UP OF EQUIPMENT

In the ramp-up phase of production, zenon is a central source of information for the monitoring of key manufacturing performance indicators. The operators of the equipment have access to various equipment data. They can quickly and purposefully create meaningful reports, statistics or analysis on the frequencies of messages. The operators thus have their equipment under control at all times. The high usability of zenon projects supports the operators with all their tasks, be it the analysis of errors or ramping up quantities – zenon is the cockpit for all equipment.

EU Guidelines for Good Manufacturing Practice in Pharma

UNDERSTANDING THE NEW REVISION OF “ANNEX 15: QUALIFICATION AND VALIDATION”

The law, regulations and directives are not generally considered as light or entertaining reading. But what does make them a very interesting topic right now for anyone involved in the pharmaceutical sector are the reasons behind the new revisions to Annex 15.

The pharmaceutical industry is changing. In recent years, the manufacturing landscape has considerably advanced. The EU is responding to this through the adaptation and revision of Annex 15 in order to facilitate change.

So let's take a look at how the revision affects pharmaceutical manufacturers and their suppliers.

The EU directive for health and food safety has issued a new revision of Annex 15: Qualification and Validation in its Guidelines for Good Manufacturing Practice. Since the preceding version of Annex 15 was published in 2001, the manufacturing environment in life-sciences production has changed quite dramatically. The technology involved in manufacturing continues to be in a state of flux.

The influence of the International Conference on Harmonisation (ICH) on quality and manufacturing practices through its ICH Q8, Q9, Q10 and Q11 guidelines, the use of complex technologies, and the long-term focus on continuous manufacturing are all changing the technology and control strategies deployed in pharmaceutical production.

A BLUEPRINT FOR COMPLIANCE

Let us begin with the current status quo. Globally, throughout the pharmaceutical industries, automation software is regulated. Regulations are law, and by nature, they are specific to each country. Internationally, the most

widely known is the US authority's FDA 21 CFR Part 11, affectionately called “Part 11”, which covers the use of electronic and automated equipment in the pharmaceutical industries.

The regulations for Good Manufacturing Practice (GMP) govern the production of pharmaceutical products. This is a different regulation: FDA 21 CFR Part 211 – Current Good Manufacturing Practice for Finished Pharmaceuticals. This legislation specifies methods and practices which allow pharmaceutical products to be approved in the US. Any company, whether domestic or international, must follow these regulations if its products are to be used in the US.

Production processes range from manual to fully automated, with every gradation in between, and each company interprets the regulations to match their own processes. Part 211 doesn't specify any automation, it is “Part 11” that demonstrates how an electronic system can replace a paper-based manual system with the same (or a greater) level of compliance.

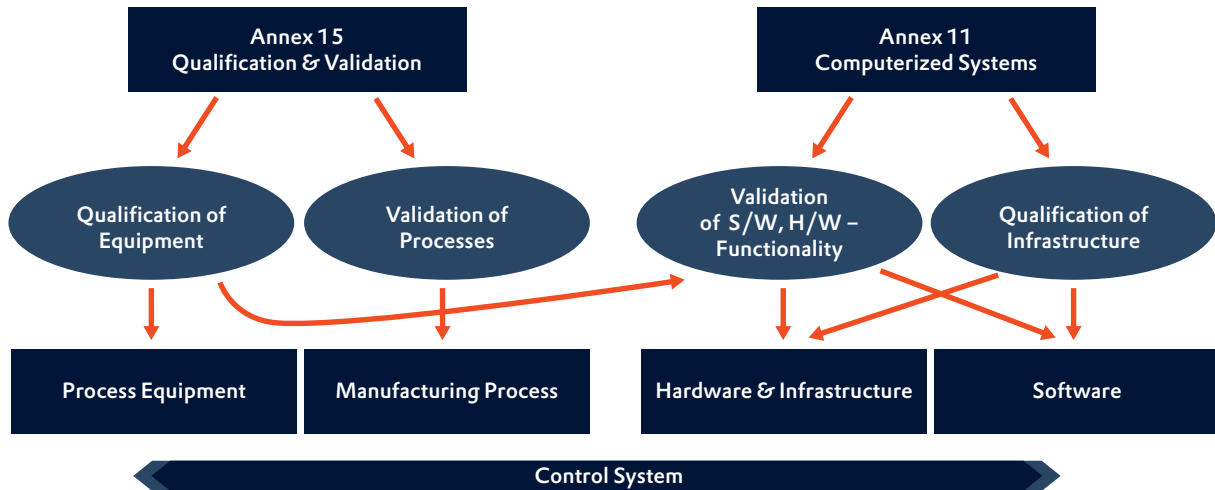

Figure: Computerized manufacturing process.

Source: This figure is based on a graphic by Klaus Eichmüller, used in his presentation "Driving effectiveness in pharmaceutical operations with integrated quality" shown at the 2015 ISPE Europe Annual Conference (Frankfurt, Germany / May 2015).

THE EUROPEAN PERSPECTIVE

Although pharmaceuticals are a global business, Part 11 is specific to the US market.

In Europe, we have a similar directive from the EU governing the use of electronic systems in pharmaceutical production. The EU directive for automated systems in pharmaceutical manufacturing is the "Annex 11: Computerized Systems" of the EU GMP Guidelines.

"Annex 11" and "Part 11" have been a major focus for COPA-DATA in this industry. We offer solutions that support best practice to achieve automation in GMP projects.

Annex 15 goes beyond Annex 11 to cover the activities of qualification and validation with regard to the product, processes and equipment. When zenon is deployed correctly to reflect the control strategies of the customer's technical specification, and when the requirements of Annex 11 are adequately fulfilled, the final process achieves Annex 15 compliance – even before the revision of Annex 15.

Annex 15 has traditionally marked the boundary between an equipment supplier and the customer installation. The main question posed: can new or modified equipment produce the desired product under strict GMP regulations? It requires evidence in the following areas:

the design of the equipment (DQ), the installation of the equipment (IQ), the operation of the equipment (OQ), and the performance of the equipment (PQ). In summary, it focuses on how the finished equipment or process is executed at the customer site.

WHAT THE CHANGES MEAN

Now, in the new revision, Annex 15 recognises that manufacturing has advanced, for instance, with the inclusion of novel and complex technology. Annex 15 now references Annex 11 directly as a specific requirement.

This makes a lot of sense because in reality the two domains interact directly with each other. Technology is fundamental to both the equipment and the processes. As a result, Annex 11 is essential in the qualification of the equipment, which eventually is influenced by Annex 15 in order to validate the process.

The new revision of Annex 15 goes further than the earlier version's one-liner which states "Computerized systems used for manufacture of medicinal products should also be validated according to the requirements of Annex 11". The full life cycle is now covered: from specification to end of life of equipment, processes, facilities, and utilities.

URS - USER REQUIREMENT SPECIFICATION

This section is completely new to Annex 15 and states that “the specification for new facilities, systems, or equipment should be defined in a URS and/or Functional Specification”. It emphasizes that the URS should be written not only from the technical point of view, but should also include quality elements and be designed to minimize GMP risk. This means the jurisdiction of Annex 15 begins earlier in the game.

FAT - FACTORY ACCEPTANCE TESTING

The new section on factory acceptance testing directly references equipment. It recommends the evaluation of equipment “incorporating novel or complex technology” at the vendor site before delivery. This should demonstrate that the equipment is in compliance with the customer’s URS or functional specification. Here, we begin to see how validation activities are applied throughout the entire life cycle and how this affects the implementation of qualification.

The revision also avoids the duplication of activities. If it can be shown that the equipment functionality is not affected by the transportation or installation, the tests and documentation performed at the FAT need not be repeated. Equipment vendor protocols and documentation can therefore be used to support qualification.

PROCESS VALIDATION

Process validation is integral to Annex 15. It demands “the documented evidence that the process, operated within established parameters, can perform effectively and reproducibly to produce a medicinal product meeting its predetermined specifications and quality attributes”.

Quality needs to be built into a system: specific references are made to equipment qualification from URS to end of use, with a goal that GMP risks are mitigated to an acceptable level. To this end, a number of validation approaches are described in the annex:

- **CONCURRENT VALIDATION**
Validation is carried out while routine production is active. Only to be used in exceptional circumstances.
- **TRADITIONAL APPROACH**
Produce a set of validation batches under normal

operating conditions, and prove the process is reproducible.

- **CONTINUOUS PROCESS VERIFICATION**
For processes developed using a ‘quality by design’ approach, and with a science-based control strategy that demonstrates a high level of assurance.
- **HYBRID APPROACH**
Using traditional and continuous process verification in combination; requires substantial understanding and manufacturing experience.
- **ONGOING PROCESS VERIFICATION DURING LIFE CYCLE**
Manufacturers monitor product quality throughout the product life cycle, demonstrating that a state of control is maintained.

The revision emphasizes that “irrespective of the approach used, processes must be shown to be robust and ensure consistent product quality before any product is released to the market”.

ICH Q8, Q9, Q10, Q11 AND THE QUALIFICATION STAGES

“The International Conference on Harmonization of Technical Requirements for Registration of Pharmaceuticals for Human Use (ICH) is a project that brings together the regulatory authorities of Europe, Japan and the United States together with experts from the pharmaceutical industry in the three regions to discuss the scientific and technical aspects of pharmaceutical product registration.

The purpose of ICH is to reduce or obviate the need to duplicate the testing carried out during the research and development of new medicines by recommending ways to achieve greater harmonization in the interpretation and application of technical guidelines and requirements for product registration.”¹

Annex 15 aligns with some aspects of ICH Q8, Q9, Q10 and Q11, and states that the qualification and validation stages should “consider all stages from initial development of the user requirement or initial process development through to the end of use of the equipment, facility, or process”.

Briefly, the ICH qualification stages cover:

¹ Source:

https://en.wikipedia.org/wiki/International_Conference_on_Harmonisation_of_Technical_Requirements_for_Registration_of_Pharmaceuticals_for_Human_Use

- **ICH Q8: PHARMACEUTICAL DEVELOPMENT**
Design space and process validation. For example, linking critical quality attributes with the critical process parameters. Referenced in the continuous process verification of Annex 15.
- **ICH Q9: QUALITY RISK MANAGEMENT**
Life cycle validation and qualification activities; systematic process of assessment and review of risk across the life cycle.
- **ICH Q10: PHARMACEUTICAL QUALITY SYSTEM**
The control strategy, in-process controls, and frequency of monitoring. A systematic approach to knowledge management.
- **ICH Q11: DEVELOPMENT AND MANUFACTURE OF DRUG SUBSTANCES**
Describes approaches to understand the manufacturing of pharmaceuticals, with further clarification of Q8, Q9, and Q10.

WHO IS AFFECTED BY ANNEX 15?

The EU GMP guidelines impact manufacturers wishing to supply markets regulated by the European Medicines Agency (EMA) with any of the following categories of products:

- Human drugs
- Veterinary drugs
- Biological and biotechnology products
- Active pharmaceutical ingredients.

BASIC COMPLIANCE IS NOT ENOUGH

Having a quality culture in place can be a source of competitive advantage in the pharmaceutical world. Basic compliance or meeting the minimum requirements of the regulations is in general not enough. Effective quality cultures need a forward-looking vision, knowing “what” to do is not the same as knowing “why”. The “why” understanding drives quality culture and promotes good quality behaviour in all activities.

Annex 15 makes specific reference to the opportunities novel and complex technologies offer pharmaceutical manufacturing. Automation technology is a major part of this opportunity. With quality built in, and its configurable nature, zenon provides an efficient control strategy and validation path to realize new technologies.

THE BENEFITS OF ZENON AND HOW WE ACHIEVE THEM

COPA-DATA is very conscious of these developments in pharmaceutical manufacturing. The zenon Pharma Edition has been specially designed to meet them. The functionality we have is configurable, zenon connects to any process and has been developed under a strict regime of quality control and traceability. Its robustness has been demonstrated in over 100,000 installations over more than 25 years. We look to the future with a constant development cycle and provide a new release every year.

Our engineering maturity and technical expertise enables us to get close to the process, to understand and control, to visualize it for the right people, and to archive and document production-critical data. Whatever quality guidelines you are working towards, zenon has the capacity to provide this assurance of quality, creating projects that are compliant with Annex 15, Annex 11, and Part 11.

ROBERT HARRISON,
INDUSTRY MANAGER PHARMACEUTICAL

The World of Ergonomics

- 1. [Ergonomics in the Workplace](#)
- 2. [Ergonomics in the Home](#)
- 3. [Ergonomics in the Field](#)





AROUND
THE
WORLD

It's Showtime!

COPA-DATA GETS EQUIPPED FOR THE FUTURE.

TEXT: GERO GRUBER,
SCREEN & INTERACTION DESIGNER

PHOTOGRAPHY: EVATRIFFT.COM

With the new customer arena at the Salzburg Headquarters, we're presenting ourselves with the most modern technology and innovative solutions based on zenon. Across 60 square meters our visitors can get a live impression of the service spectrum of the zenon Product Family and the array of implementation possibilities it offers.

Join us, in the following pages, on a tour of our new showroom and the modern training facilities.

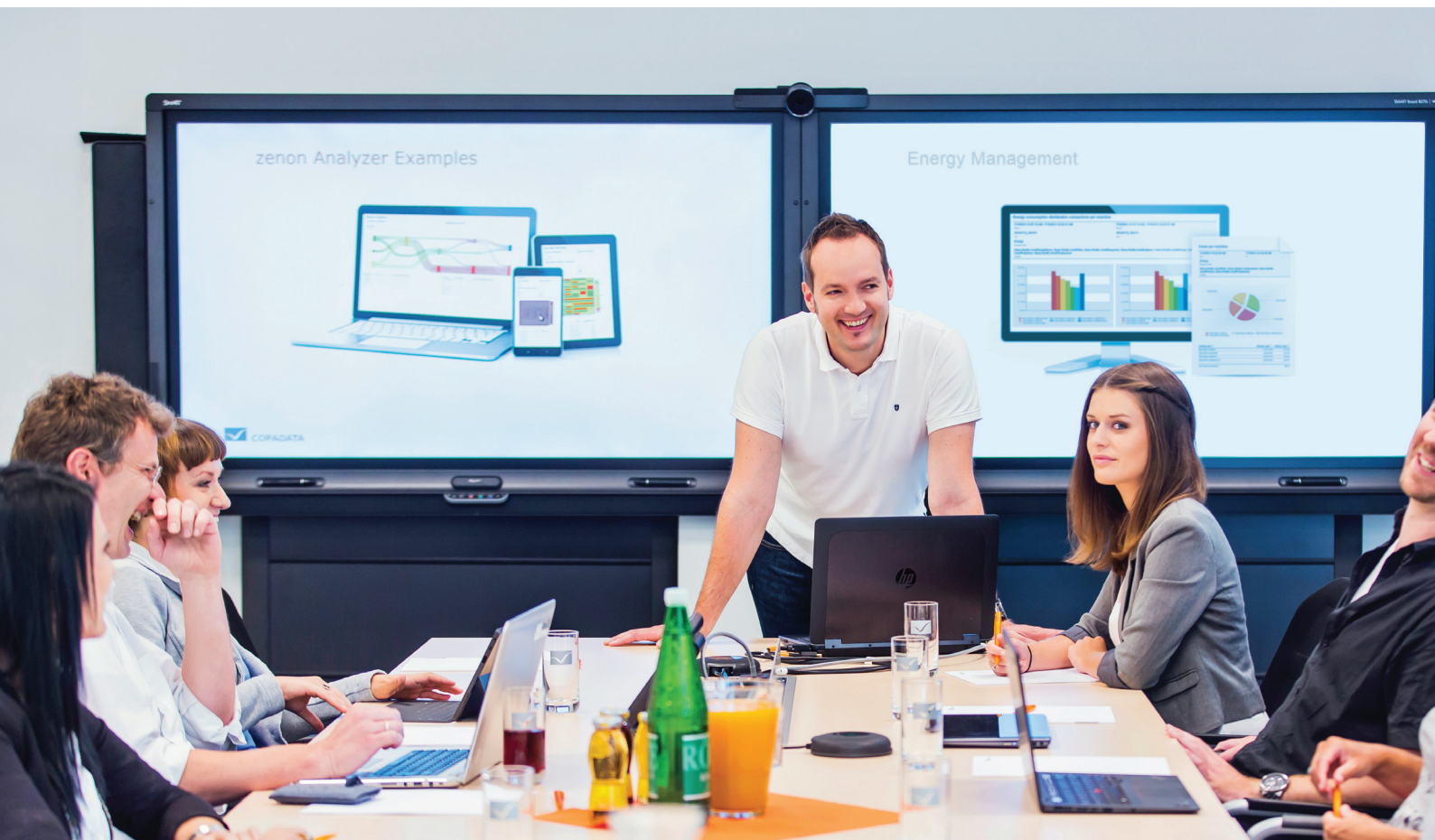



"When you set foot in our company building these days, innovation and an international environment are clearly felt. These are two important aspects of our company culture and our success. As founder of the company, I'm proud to see how COPA-DATA has developed. Our new showroom displays the broad range of implementation possibilities of zenon. Visitors can choose to take on different roles, test various applications and experience our product family close up. We have created the ideal training and learning environment for our partners and customers with the new training rooms. The new meeting and office facilities offer a modern business infrastructure thanks to smart technology, which connects us in Salzburg with the entire world. We have hereby set our sails for the future and further growth."

THOMAS PUNZENBERGER, CEO, COPA-DATA



The core of our new showroom: zenon in a control room with numerous screens – take a seat in our cockpit! zenon Supervisor is perfectly equipped for comprehensive visualization of complex equipment and infrastructures.



1

Get firsthand experience of machine-oriented operation with zenon Operator as Human-Machine Interface (HMI). Furthermore, you can get a picture of how straton, as a PLC Runtime, can run on diverse open control systems – and even on Raspberry Pi 2! In this way, straton is seamlessly integrated with the entire zenon Product Family.



2





Explore the HMI of tomorrow with our innovative Multi-Touch-based HMI application. Functionality such as user-configurable workspaces and 3D visualization offer ergonomic operation.

With zenon, a wide range of mobile applications are open to you. Test zenon on tablets and smartphones: from monitoring relevant KPIs, to mobile alarming, right up to operating directly from the mobile device.



What do Atomic Ski, KUKA robots, BMWs, Bonduelle vegetables and many other international brands have in common? That's right, a piece of zenon is in them all! As of now, you can admire the small, fine selection of products, which were produced with the help of zenon in our reference display cabinet in the showroom.



A good automation software should be one thing above all – reliable. The stability of zenon running in continuous productive operation is something we not only claim, but what our users can confirm. Our long-standing customer, Adelholzener Alpenquellen, has provided us with a panel on which zenon was reliably running in production for fifteen years. Now see again live in our showroom – convince yourself!





“The completely newly designed training room offers us the possibility to combine didactic know-how with the most modern technology.

Furthermore, we have an informal room available for break discussions or for the many internal short meetings. Quality, functionality and feel-good character were the focus during the design phase.”

ALEXANDER PUNZENBERGER,
MANAGING DIRECTOR, COPA-DATA CEE / ME

Plan a bit of extra time to discover our new showroom during your next visit to COPA-DATA in Salzburg. We look forward to welcoming you to our new facilities soon!

You can find an overview of our training courses at www.copadata.com/training.

It's Showtime!

Join us for a **virtual tour** of our new facilities.

Let's go:

Our two new training rooms offer space for 20 people and are the ideal working environment for internal and external training courses. The new rooms offer the perfect training infrastructure, with appealing design and interior, generous room layout and an adjoining lounge area.



<http://kaywa.me/YS0fo>



WHO IS WHO

A Smart Factory needs more people than some might think.

We see that every day when we welcome new employees. People, for example, who write the programs that make your automation properly smart and fit for Industry 4.0. And people who work on making customer projects that have been in use for many years, making them able to work effectively in the future. Or people who, together with you, find out which automation steps really move you and your company forward. We are always happy to present some of them to you in our "Who is Who".

Today, the following people are in the limelight:





Hermann Oswald

KEY ACCOUNT MANAGER AUTOMOTIVE

COPA-DATA GERMANY
Head Office Ottobrunn

AT COPA-DATA SINCE: 2014

RESPONSIBILITIES:

I advise and support our automotive customers with existing, new and planned projects, bring them together with the right experts and coordinate the resultant processes. Our automotive customers should have a long-term, competent partner at their side, who is familiar with their problems, objectives and visions, accompanying them on the way to implementation.

I GET MY INSPIRATION FROM ...
mountain hikes in my home, the Karwendel mountain range.

IF I COULD DO AS I WANTED, I WOULD ... spend time with family, with friends and traveling.

You can reach me at:
hermann.oswald@copadata.de



Piotr Dąbrowski

INTERNATIONAL TECHNICAL CONSULTANT

COPA-DATA POLAND

AT COPA-DATA SINCE: 2012

RESPONSIBILITIES:

I am responsible for Technical Support at COPA-DATA Poland. I mainly support zenon users from Poland, but also from the regions of Central Eastern Europe and the Middle East. I assist our customers in the development of their projects and fulfillment of various user-specific requirements. In addition, as a zenon certified trainer, I lead zenon Supervisor, zenon Logic and zenon Energy Edition training courses as well as tailored workshops.

I GET MY INSPIRATION FROM ...
my family. I can always count on them. I also get inspiration from human history and the imperturbable, quiet witness of history – nature. While human life stories show that everything is possible, nature reminds us that life passes. The first one encourages me to act. The second one to enjoy life.

IF I COULD DO AS I WANTED, I WOULD ... spend more time hiking in the mountains and travel around the world.

You can reach me at:
piotr.dabrowski@copadata.com



Symeon Rizos

TECHNICAL CONSULTANT TEAM LEADER

COPA-DATA UK

AT COPA-DATA SINCE: 2013

RESPONSIBILITIES:

I lead the technical support team for customers across the UK and Ireland. I train new and existing customers on all aspects of zenon. We run courses on zenon as well as zenon Energy Edition, zenon network functionalities, etc. I work with the sales team to assist with pre-sales concepts and, when a customer needs help with a project, we run workshops to support their zenon queries and engineering.

I GET MY INSPIRATION FROM ...
traveling, sports, the desire to help people and to learn every day.

IF I COULD DO AS I WANTED, I WOULD ... pack up and explore South America. And have a good cup of coffee at each stop.

You can reach me at:
symeon.rizos@copadata.co.uk



Hans-Peter Ziegler

SALES MANAGER AND
AUTHORIZED REPRESENTATIVE
COPA-DATA CEE / ME

AT COPA-DATA SINCE: 2000

RESPONSIBILITIES:

For 15 years, I have inspired people in Austrian companies with the zenon Product Family. In meetings with project leaders and decision makers, I work out approaches to solutions and gather the right people together. Sometimes I also have the opportunity to give presentations at events to showcase the fascinating aspects of zenon to a larger audience. As an authorized representative, I represent our Managing Director, Alexander Punzenberger, in all matters. I have recently become a member of the management board of ICT Austria, an association for the promotion of Austrian ICT competencies.

I GET MY INSPIRATION FROM ...
meaningful conversations and nature.

IF I COULD DO AS I WANTED, I WOULD ... found a culture center, in which people of different origins and cultures and with different interests could meet each other and share experiences.

You can reach me at:
hans-peter.ziegler@copadata.at



Johannes Petrowisch

PARTNER ACCOUNT MANAGER
COPA-DATA HEADQUARTERS

AT COPA-DATA SINCE: 2012

RESPONSIBILITIES:

In my role as Partner Account Manager, I am responsible for world-wide strategic partnerships and the COPA-DATA Partner Community – an international network of certified automation specialists. When building up strategic partnerships, I work together with companies such as Microsoft, Intel and SAP. In doing so, the objectives are a profitable and long-lasting partnership for both companies, the creation of new business areas and solutions, as well as ensuring innovative product development on the basis of the latest technologies available.

I GET MY INSPIRATION FROM ...
my relationship of many years, from talks with friends, from my travels around the world as well as soccer and basketball.

IF I COULD DO AS I WANTED, I WOULD ... travel the whole world with my girlfriend and then shoot some hoops with Barack Obama.

You can reach me at:
johannes.petrowisch@copadata.com

Another Step Forward In Global Competence Assurance

INTRODUCING ZENON CERTIFICATION

In 2011, the COPA-DATA Partner Community was introduced as a global partner program to bring together COPA-DATA partners around the world. With one standardized program as the framework, we can now assure the proven competence of our partners independent of their location or industry focus. We have three levels within the program – Registered, Qualified and Expert. We accredit the partners and, in line with competence, commensurably provide valuable support and many additional benefits.

Since the start of the COPA-DATA Partner Community, all COPA-DATA customers can rely on a standardized model to assure the quality and knowledge of partners to help them find the perfect match for their needs. The result is no surprise: highly competent partners, great service and engineering, inspiring and innovative solutions – and, most importantly, delighted customers. But now there's even more...

ZENON CERTIFICATION - AN INTEGRAL PART OF THE COPA-DATA PARTNER COMMUNITY

In May 2015, the new zenon Certification system was launched as a natural part of the zenon training evolution. Now, after attending a zenon training course, employees of our partner companies need to prove their gained knowledge by successfully passing the related zenon online tests in order to reach a zenon Certification. There were two goals when connecting this certification system with the COPA-DATA Partner Community. Firstly, to introduce another step to assure the high quality and different skills of the individuals working for our partners. Secondly, it is important to offer this transparency to our customers so they can see the level of knowledge and which specific skills the staff of a partner company has – making it even easier to select the best-suited COPA-DATA partner for the specific assignment.

KNOWLEDGE IS POWER - AND OUR PARTNERS HAVE THE POWER

Competence growth is key within the Partner Community. At COPA-DATA, we always work hard on sharing our zenon knowledge at all partner levels. The requirement for different zenon Certifications, both in terms of the level of certification and the number of people holding them, depends on the partner level. This makes us even more confident that our partners have the proven competence in-house and can provide the best solutions based on zenon to the market.

ALWAYS UP TO DATE WITH THE LATEST INNOVATIONS

The development of zenon is a continuous process. With each release, a great number of new and innovative functionalities is added, responding to new market trends and emerging technologies and to the needs of our partners. To reflect the constant evolution of zenon, zenon Certifications are only valid for three years – thereafter they will expire if a re-certification is not completed. Because our partners will always hold valid certificates, our end customers have the assurance not only of their current competence level, but also of their knowledge of the latest zenon innovations.

In general, anyone at an organization – private or public – attending a zenon training course and working with zenon can become zenon-certified. zenon Certifications are only given on a personal level and individuals can only hold one valid certificate at a time. All existing members of the COPA-DATA Partner Community have the required zenon Certifications – all COPA-DATA partners are ready to provide high quality engineering, great services and the best possible solutions to the end customer.

OVERVIEW OF ZENON TRAINING COURSES

zenon Additional Training Courses







zenon Individual Training (x days)	zenon VBA Training (2 days)	zenon VSTA Training (2 days)				
zenon Analyzer Advanced Training (1 day)	zenon Logic Advanced Training (1 day)	zenon Historian Training (1 day)			zenon Network Training (1 day)	zenon Design & Usability Training (1 day)
zenon Analyzer Training (2 days)	zenon Logic Training (2 days)	zenon Energy Training (2 days)			zenon Pharma Training (2 days)	zenon Batch Training (2 days)

zenon Standard Training Courses

zenon Basic Training (3 days)	zenon Operator Training (4 days)	zenon Supervisor Training (5 days)	
-------------------------------	----------------------------------	------------------------------------	---

ZENON CERTIFICATIONS PER PARTNER LEVEL

All COPA-DATA partners have one or more zenon-certified employee(s) at their premises. Here is a short overview of the zenon Certifications needed per partner level – assuring a high degree of zenon knowledge at the company level.

			
zenon Basic Certification			
zenon Advanced Certification			
zenon Professional Certification			

Learn more about zenon Certification at www.copadata.com/certification.
Find the right partner at www.copadata.com/find-a-partner.

LISETTE LILLO FAGERSTEDT, PARTNER PROGRAM MANAGER
JOHANNES PETROWISCH, PARTNER ACCOUNT MANAGER

HOW TO ACHIEVE A ZENON CERTIFICATION

A zenon Certification is attained by attending a zenon training course and passing the related zenon online test successfully afterwards. In total, there are more than 15 different zenon training courses to choose from. Three levels of zenon Certifications can be achieved: Basic, Advanced and Professional. The levels are given in accordance with the zenon knowledge that the certified person has acquired.

ZENON BASIC CERTIFICATION:

- Complete a zenon Standard Training Course
- Pass the corresponding zenon online test
- Receive your zenon Basic Certificate – valid for three years

ZENON ADVANCED CERTIFICATION:

- Precondition: a valid zenon Basic Certification
- Complete one or two zenon Additional Training Course(s) totaling two days of training
- Pass the corresponding online test(s)
- Receive your zenon Advanced Certificate – valid for three years

ZENON PROFESSIONAL CERTIFICATION:

- Precondition: a valid zenon Advanced Certification
- Complete one or two zenon Additional Training Course(s) totaling two days of training
- Pass the corresponding online test(s)
- Receive your zenon Professional Certificate – valid for three years

Energy from A to

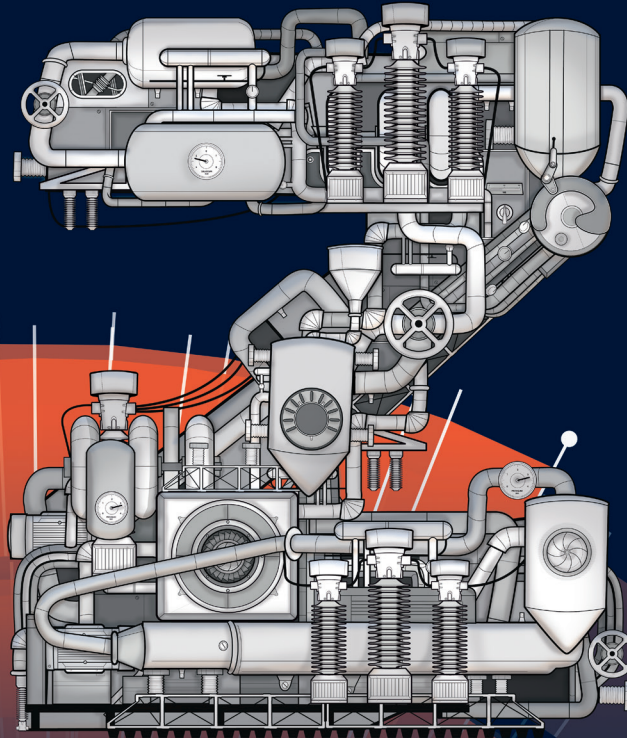

“What the ...?” Daniel was desperate. His new client’s substation project was nearly done, just when he noticed a mistake among the symbols. Now he had to tweak every single one of those 300 symbols again. Creating them by copying and pasting had been easy enough, but now, his time was running out.

After he barely kept his deadline, Daniel browsed the engineering forums. Although he couldn’t find a script against that kind of unpleasant surprise, he got a link for an Energy Automation System called zenon. And read about automatically colored topology, of SNMP and intelligent symbols.

Getting started with his test version took him a while. What was that feature inheritance after all? His first 300 symbols took him longer than expected, but the big breakthrough came afterwards: Changing a single symbol automatically altered all the others, too.

When checking his time sheet, Daniel had a redundancy of only few clicks. Topological coloring: integrated. All required protocols and standards like IEC 61850, IEC 60870 or DNP3: on board. Clear parameterizing, no single line of extra code. This program really did speak his language. So that’s how ergonomics worked. And that’s how relieving it felt.

**The Future is Ergonomics.
Ergonomics is zenon.**

www.the-future-is-ergonomics.com



COPADATA
do it your way