

# INFORMATION UNLIMITED

## AUTOMATED ENGINEERING

Decentralized Intelligence for Modular Applications

IEC 61850 Edition 2

User-defined HMI's

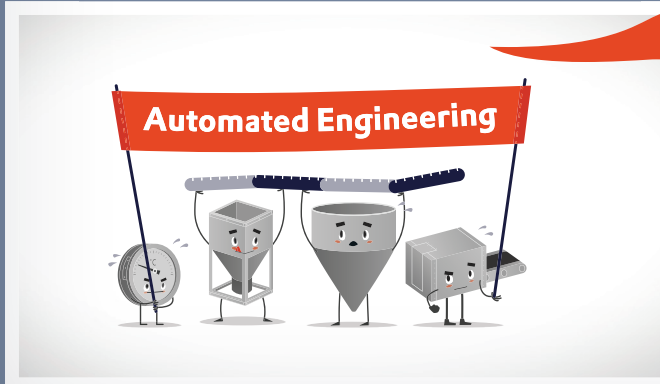
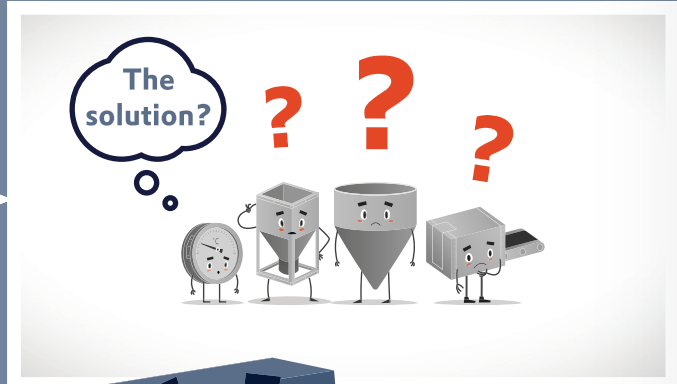
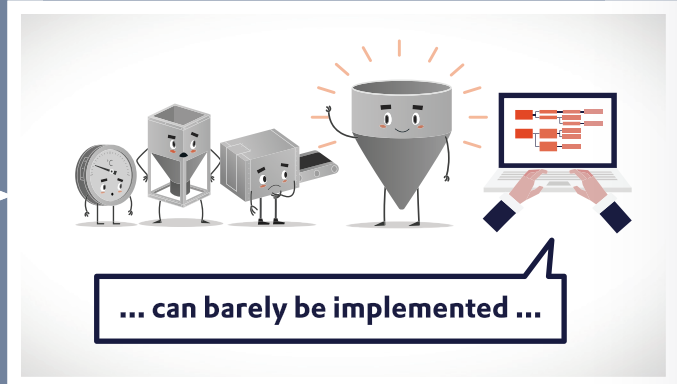
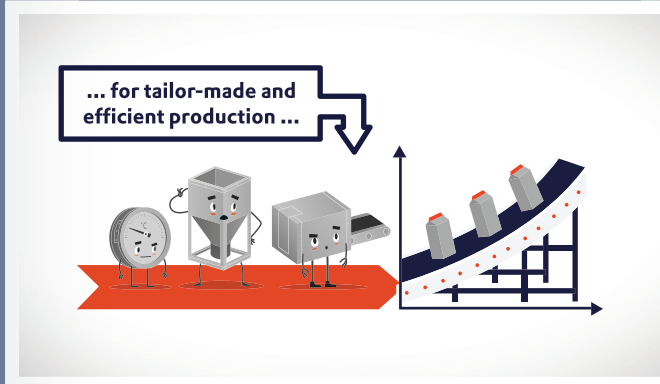
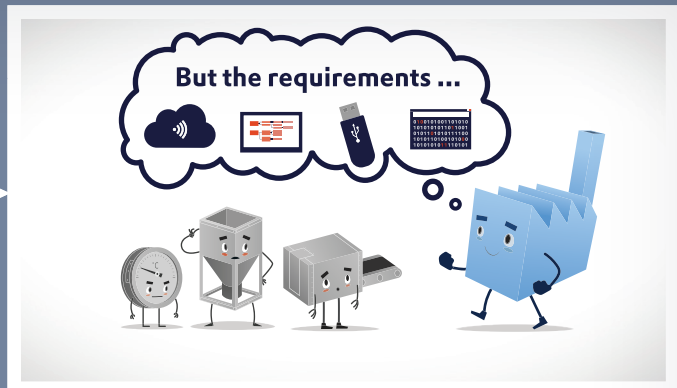
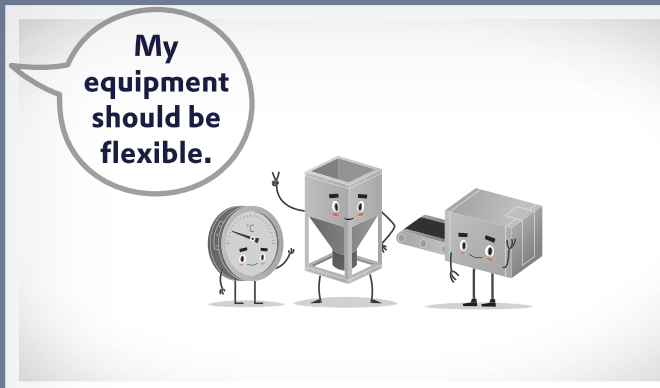





**IU****INFORMATION UNLIMITED**

THE COPA-DATA MAGAZINE

ISSUE #29 | APRIL 2016

## PRESIDENT AND PUBLISHER:

Thomas Punzenberger  
 Ing. Punzenberger COPA-DATA GmbH  
 Karolingerstrasse 7b, 5020 Salzburg, Austria  
 Commercial Register Number: FN56922i  
 t +43 (0)662 43 10 02-0  
 f +43 (0)662 43 10 02-33  
 www.copadata.com

## EDITOR-IN-CHIEF: Julia Angerer

## EDITORIAL TEAM:

Gernot Bugram, Eva-Maria Oberauer-Dum, Steve Poynter, Nicola Richter, Esther Rutter, Phillip Werr, Bertold Wöss  
 ART DIRECTOR: Manuela Bacher  
 COPY-EDITING: Kristen Kopp

## AUTHORS/CONTRIBUTORS:

Emilian Axinia, Sebastian Bäsken, Mark Clemens, Lisette Lillo Fagerstedt, Diego Fila, Robert Harrison, Günther Haslauer, Markus Helbok, Gareth Hogan, Thomas Holm (guest author), Stefan Hufnagl, Albi Kospiri (guest author), Klaus Mainzer (guest author), Andrea Mitterer, Louis Paglaicetti, Anita Perchermeier, Johannes Petrowisch, Thomas Punzenberger, Jürgen Resch, SungHo Ryu, Philipp Schmidt, Phillip Werr, Anton Wiesner, Bernd Wimmer, Hans-Peter Ziegler

## PRINT OFFICE:

Offset 5020 Druckerei & Verlag Ges.m.b.H., Bayernstrasse 27, 5072 Siezenheim, Austria

## LETTERSHOP:

Mailinghaus GmbH - Dialog Marketing Agentur, Neualmerstrasse 37, 5400 Hallein, Austria

PRINT RUN: 14,550 copies

FREQUENCY OF PUBLICATION: twice a year

## COPYRIGHT:

© Ing. Punzenberger COPA-DATA GmbH. All rights reserved. The magazine and all the articles and images it contains are protected by copyright. Any use or duplication is not permitted without prior permission from the editorial team. The technical data contained herein has been provided solely for informational purposes and is not legally binding. zenon®, zenon Analyzer®, zenon Supervisor®, zenon Operator®, zenon Logic® and straton® are trademarks registered by Ing. Punzenberger COPA-DATA GmbH. All other brands or product names may be the trademarks of their representative owners and have not been specifically earmarked. We thank all contributors for their friendly support and the pictures they provided. Subject to change - technical, print or otherwise.



linkedin.com/company/copa-data-headquarters

gplus.to/COPADATA

facebook.com/COPADATAHeadquarters

twitter.com/copadata

xing.com/companies/copa-data

youtube.com/copadatavideos

**CONTENT**

- 5 Editorial
- 6 **SPOTLIGHT AUTOMATED ENGINEERING**
- 7 Automated Engineering as a Way to the Smart Factory?
- 11 Guest Contribution: Systems Engineering for Industry 4.0
- 14 CEO Interview: Automated Engineering with zenon – What’s it Good for?
- 16 Project “DIMA” – New Paths in Process Automation
- 20 **PRODUCTS & SERVICES**
- 22 zenon 7.50 & zenon Analyzer 3  
News from the Current zenon Release
- 24 In or Out?  
C# Program Code Execution
- 26 How Schweitzer Engineering Laboratories Capitalized on Ergonomic Engineering with zenon
- 29 Series: Efficient Engineering with zenon [PART 6]  
Automated Engineering
- 34 User-defined HMIs
- 36 **INDUSTRIES & SOLUTIONS**
- 38 Give Machine Operators a Voice
- 41 Ethernet Networks for Critical High-Speed Applications
- 42 The New zenon IEC 61850 Wizard
- 43 Interview: IEC 61850 Edition 2 Certification
- 45 zag – the Wizard for the Automotive Industry
- 48 IoT Impact on Pharma Manufacturing
- 52 **AROUND THE WORLD**
- 54 A Plastics Processor on the Way to a Smart Factory
- 57 Bienvenue COPA-DATA France!
- 58 Who is Who
- 60 Get to Know our New Distributors
- 61 Global Partner Academy 2016

CONTACT/  
FREE SUBSCRIPTION:

IU@COPADATA.COM  
WWW.COPADATA.COM/IU

---

## EDITORIAL



Dear readers,

“Automated Engineering” is the topic that pervades this issue of our *IU*. What do we imagine when we hear this term? And what benefits can it give us?

Well, in short: if I automate something, it runs independently, it can be repeated with the same quality and maybe even without the help of engineers.

zenon offers you many methods to increasingly automate your engineering: by means of wizards, for example. Guided through a user interface, your projects, or parts thereof, are created automatically. This is most of all beneficial if you have repetitive tasks or want to always use the same templates.

Or, you could have your complete project generated automatically using external applications such as planning systems. This is a requirement that is also anchored in the “Recommendations for implementing the strategic initiative INDUSTRIE 4.0” from the institutions Forschungsunion and acatech. What is described as a future scenario in this document is already available now in zenon.

Creating variables, screens and logic automatically, direct from planning, saves time and increases quality simultaneously. Once configured correctly, centrally, the system always works with the same data source. Reusable parts of projects are only checked once and can then be used many times.

Let yourself be inspired by the range of possibilities that zenon provides for automated engineering. I wish you all an exciting read and hope that it inspires you to try this excellent functionality yourselves.

A handwritten signature in blue ink, appearing to read 'TP', written over a light blue circular watermark.

THOMAS PUNZENBERGER, CEO

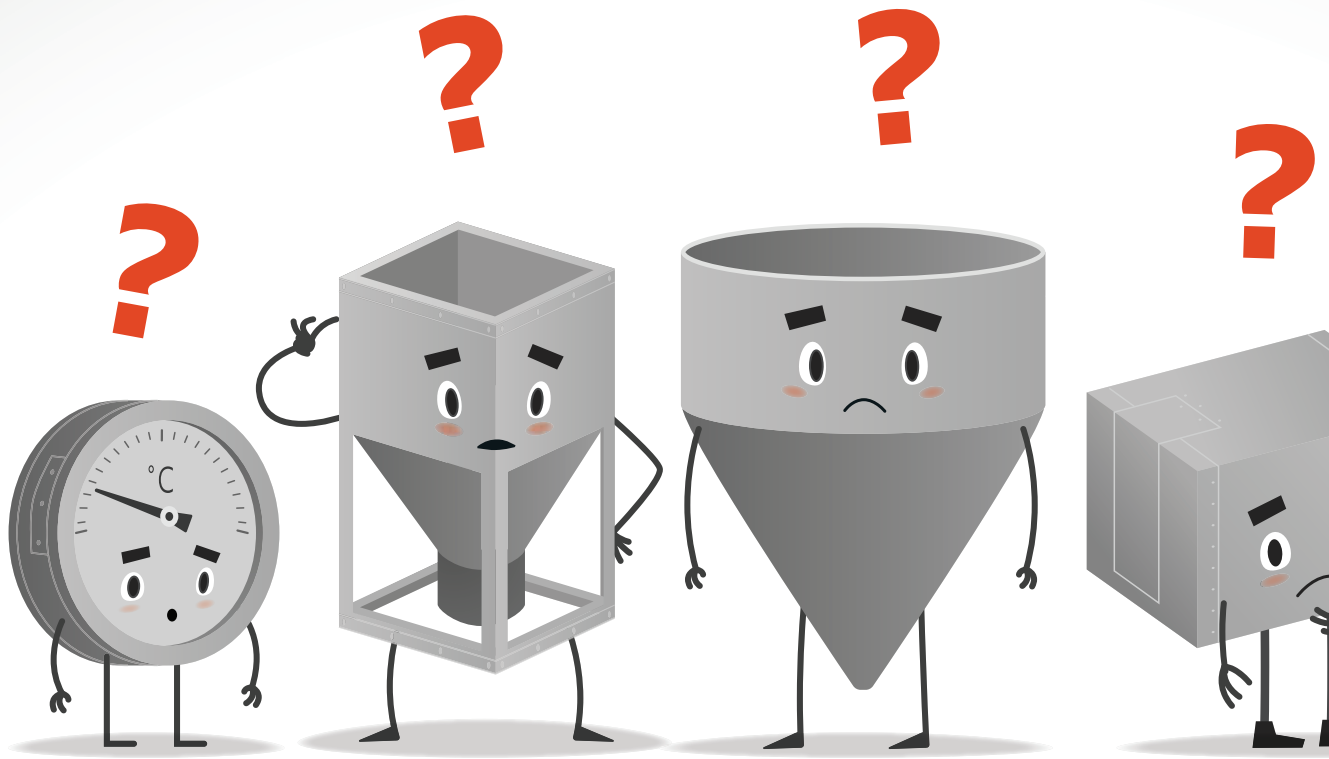

## SPOTLIGHT

# BREAKOUT.

## AUTOMATED ENGINEERING AS A WAY TO THE SMART FACTORY?

*It could be so simple: anyone who wants to equip a production hall orders from the machine-manufacturing company's catalog. Anyone with particular demands has a one-off made from a special machinery company. It's a possibility – because nowadays, production plants are just as diverse and individual as cars. The megatrends of individualization and connectivity are already having a widespread effect. The Industrial Internet of Things and the call for lot sizes of one demand tailor-made equipment in the smart factory. Individualized plants and manual engineering – how does that fit together? Not at all.*

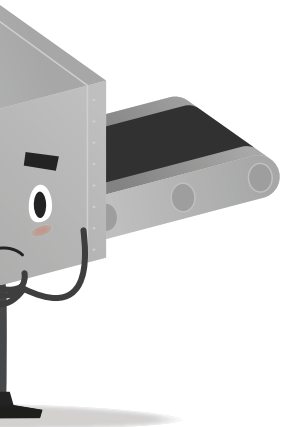

Whether self-driving cars, automatic reactions in communication or small everyday conveniences, such as smartphones that automatically use a different profile at home than the one in the office – the trend towards automation cannot be overlooked. We love them all, these configurations, with which we compile our computers individually, model our cars as we want, or mix our muesli.

As consumers, we have discovered “a lot size one” for ourselves. It is “mine” means not just “it belongs to me”, but also “it has been made for me alone”. But what do we actually trigger with a few mouse clicks in the configuration? The manufacturer of our individualized product must be in a position to create it individually at a reasonable price. Equipment manufacturers, machine builders and integrators need to make it possible for the manufacturer to produce products in small amounts. And somebody must then create the visualization and control for each individualized machine and each unique plant. It sounds like a lot of work, and indeed it is if it's done manually.

### FROM A LARGE WHOLE TO A FLEXIBLE WHOLE

Everything from one place, from the first machine to the last machine, from the PLC, through to the driver and on to visualization, from planning to maintenance – the current norm has undisputable advantages. Planning is easier and the costs can be calculated more quickly. There is just one contact person and a service partner for the complete plant. However, this is at the cost of flexibility. Why not manufacture medicine packaging that is amended for different patients and medicines? Why not, as a contract bottler, fill many different drinks for different clients using the same equipment? And while we're on the subject, why not connect processes to operational control, production to distribution, machines to the office? Manufacturer to supplier, machine to machine? All this is possible if all systems can communicate comprehensibly with one another.

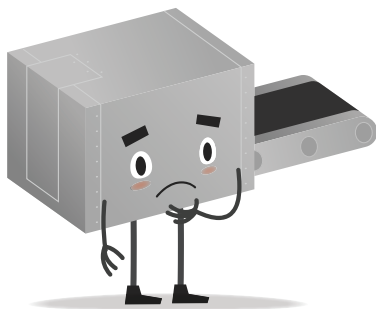

However, this requires thinking in terms of sections and modules instead of as a complete plant; breaking away from closed systems and allowing standardized interfaces. This is just as applicable for hardware as it is for software, such as HMI and SCADA for example. The payoff is quick reaction times and new market opportunities, more independence from system equippers and less costs incurred by retooling at short notice.

How is the necessary increase in flexibility to be achieved? The modular structure of equipment and the corresponding modular structure of machines therein creates a number of possibilities. But these numerous individually configured machines and the modularly-built equipment must also be controlled and visualized.

It is clear to machine manufacturers that this only works with sufficient automation. During the configuration of the machines, when creating the PLC programs, and even when engineering the visualization. The conclusion: Automate the engineering or refrain from this level of flexibility at all.

### BREAK OUT OF NARROW LIMITS

The first stage of automated engineering requires a breakout from dearly held habits and the seemingly more secure mastery of one's own tool. It primarily needs much more openness than before. This is because “automated” also always means having an effect from outside, using interfaces.

Machines, controllers and software that are to work automatically must support a standardized connection to external systems and equipment. All parties concerned must be familiar with one another, must know who is preparing what and must be in a position to exchange data and information. It is not one individual participant who gains, instead everyone and everything involved achieves gains and is beneficial for others.

It is, most of all, joint access to data that offers a high potential for saving and automation. For example, variable lists for visualization can come directly from the controller, the graphics from the CAD program, and the electrical plans from the corresponding software.

However, a uniform standard for open communication is not in sight yet – and will also be difficult to agree. This is because the different components involved make very different demands. If automated production communicates with ERP, office and banking mingle, geodata is required and much more – then many existing standards meet one another. In the area of machine and equipment building, many companies are already researching the possibilities of secure networking and the automatic exchange of data and information. We want to take a closer look at two of the many approaches: DIMA and the Diabolo concept.

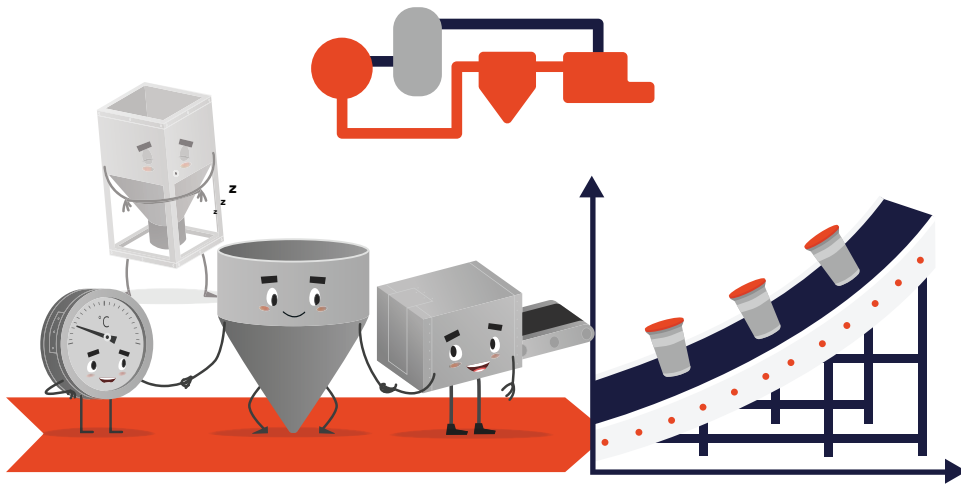

## DIMA - MODULAR APPLICATIONS FOR CUSTOMIZABLE PRODUCTION

First, there was the question: how should companies, whose equipment is compiled in a complex manner and must pass detailed checks, design their operations more flexibly and prepare them for new requirements? The automation company WAGO reacted to this and, together with partners from research and commerce, developed a concept for modular equipment: DIMA. The abbreviation stands for “Decentralized Intelligence for Modular Applications”. The starting point for the concept is the NAMUR recommendation NE 148.

There is already an initial prototype and many people expressed interest in it at the SPS IPC Drives 2015 trade fair in Germany. COPA-DATA is also involved with DIMA, providing zenon, expertise, manpower and financing.

The fundamental idea is a modular approach. Equipment is made up of individual complete, pre-configured modules, which are simply connected using Ethernet. A separate tool creates an MTP configuration file for each module, which is imported into the SCADA system by means of an interface. A module could be an individual device, or a part of equipment or an equipment group. Communication between control level and the modules is effected by means of manufacturer-neutral semantics. Anyone who supports the protocol can simply click in.

DIMA shortens the conception phase and speeds up the construction of equipment, which leads to things being put into operation more quickly.

## FROM THE PYRAMID TO DIABOLO

The Practical Robotics Institute Austria (PRIA) and COPA-DATA offer another way in their joint “BatMAS” project. In the search for a way to make the engineering smarter, the roles are redistributed and the established automation pyramid is restructured to the Diabolo: the configuration

here does not start with the PLC, but instead with the model that is orientated to binding standards such as ISA 95. It connects ERP and process as a central management tool.

In order to use the information from a machine, a sensor or an item of equipment, it is no longer necessary to link a new variable to it each time. The model is familiar with it and its significance and establishes the connection if required. Information is used many times and wizards then work not just stubbornly according to the program, but instead, their behavior depends on the model. For example, to create a waterfall diagram, it is sufficient to tell the model the part of the equipment for which the waterfall diagram is to be drawn. The rest happens automatically. Such a model is also in a position to link data from different sources with a different structure by means of mapping.

## FROM A MODULAR SYSTEM TO DECENTRALIZED INTELLIGENCE

There are of course already many flexible visualizations that implement different customer wishes into a user interface. The conventional practice was that a very, very large project covers all possible configurations and options. Modules are shown or hidden, depending on the task. However, this can lead to problems for maintenance and in the appearance of the user interface.

A modular structure of equipment increases the rich diversity of a visualization considerably. Huge SCADA projects that form each variant are no longer a reasonable possibility. However, the labor-intensive manual creation of individual, customizable user interfaces is no alternative for machine builders and integrators. That would require too much time and manpower, and would be too expensive in any case. So the possibility to also create the visualization of machines and equipment in an automated manner must also be created. SCADA projects are thus compiled into large parts by wizards and only individualized in small parts. How

can that work? It is best with clearly-structured modules, with a clear overview of versions, and decentralized.

We are familiar with modular systems, which provide individual libraries and modules to make larger systems out of them, from many scenarios. Modern machines are constructed in such a way that PLC programs are created and there are also modules ready for visualization. zenon, for example, contains, and has in many previous versions contained, wizards which create basic projects in an automated manner and take on documentation or configuration work.

Anyone who starts to create visualization projects in an automated manner must keep the requirements of the user in mind. Industries such as the chemical industry, pharmaceutical industry or food & beverage industry must document each change or even have it confirmed by the authorities. For automated engineering, this means that each change must be documented in a traceable manner. However, it also means that a change in a module must not have an uncontrolled effect on other modules.

Automated engineering also means that many components must interact in a controlled manner – from mechanics and electricians through to visualization up to intra-machine and inter-machine communication. Standards and cooperation are also required; human intervention and automatically-running processes need to be skillfully linked.

## **AUTOMATED ENGINEERING? IT'S RUNNING!**

Despite a lack of general standards and insufficient support from the big players, automated engineering should not be considered a dream of the future. It is not a matter of having everything run automatically from start to finish. But just as individualized equipment consists of individual modules, visualization can also be based on combined modules.

Many visualization projects can already be partly created in an automated manner. It starts with a configuration tool, which contains parameters for new visualization projects and then automatically creates a project with the appropriate variables and alarm configurations, and ranges up to the wizard, which provides the appropriate project on the basis of the given machine type.

The interaction of individual modules will become ever more close and complex. The human intervention that is now necessary will certainly be further reduced in the future. Automated engineering now also permeates the subsequent area of maintenance. Direct communication between SAP and zenon, for example, is already now possible. Why should orders from a customer meeting not soon go directly to ERP and a zenon project be created automatically using the planning system?

## **BREAKOUT**

The manner in which we produce, optimize processes and combine data is changing. Different methods are on offer and are being tested. The key word for all is “automation”. It is, most of all, automated engineering that will decide how quickly and how well ideas for Industry 4.0 and the IoT will be implemented.

---

### **Video:**

**Experience the benefits of automated engineering with zenon**

Scan & Play!

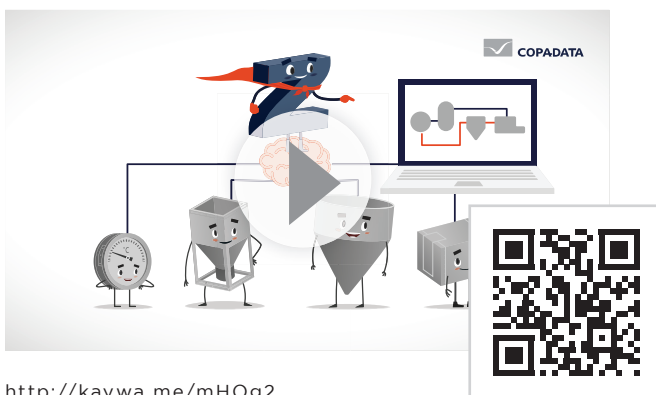

<http://kaywa.me/mHOg2>

---

## GUEST CONTRIBUTION

AUTOMATED ENGINEERING:

# SYSTEMS ENGINEERING FOR INDUSTRY 4.0

### **WHY AUTOMATED ENGINEERING?**

More than a few grounded mid-sized businesses express frustration at the almost continual introduction of new slogans in the IT industry. Do these glossy words amount to anything more significant than simply disguising the old under the cloak of the new? With respect, the (seemingly) dumb question must then be asked: Why do we need “automated” engineering anyway?

American pragmatism cuts straight to the point: many American campuses have been offering courses on automated engineering through their engineering faculties for many years now. The (American) industry is under increasing pressure to find new ways of reducing costs and increasing efficiency. To achieve this, automation must integrate various production processes and sales steps while reducing time and resources. An engineer who wants to achieve this needs interdisciplinary skills. Being highly specialized with a classical engineering degree is not enough. Automation engineers must have a command of design, integration, programming, simulation, testing and the control of various machines and processes. Their skill set must include managing complex problems, creative

thinking, attention to detail and the ability to integrate and communicate within a diverse team. If they can do this, lucrative jobs beckon. Because, actually, which companies can seriously do without such capabilities?

### **AUTOMATED ENGINEERING REQUIRES SYSTEMS ENGINEERING**

Automated engineering is by no means new; it has had a long preliminary phase in industrial history. In the 1940s, complex engineering arose where various technology fields began to intersect. Examples in the USA initially included military projects, then space travel (e.g. the Apollo program) and, finally, civil projects: from bridge building to computer and robot applications in industry, right up to major infrastructure projects. Mechatronics were the next important development step, where the collaboration of mechanical engineering and electronics created a new specialist field. In general, complex tasks arise when problem solving involves combining different specialist fields. This challenge becomes extreme when it is no longer just about one manufacturing process, but an entire production and supply process within a factory.

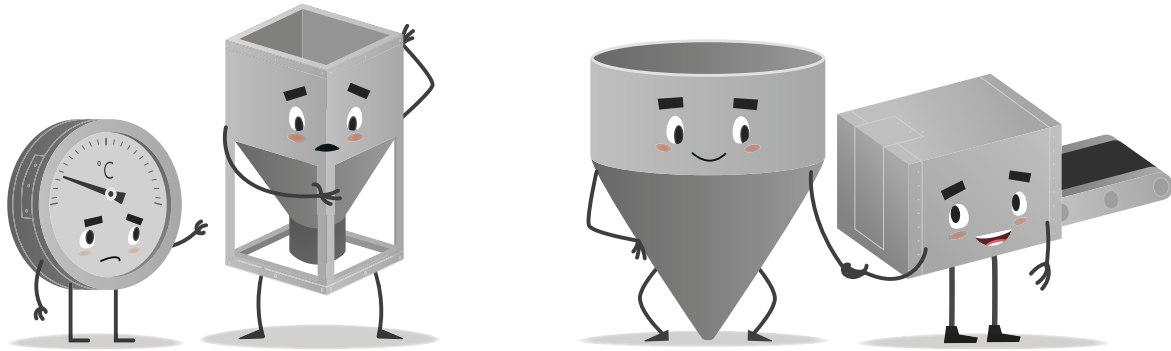

This leads us to a complex system in which many different components work together. In the natural sciences, complex systems are researched in various disciplines. Such examples from the natural sciences can definitely inspire our engineering approaches. A cell works as a complex biochemical factory, where different process workflows organize themselves. The central nervous system coordinates different process cycles in an organism like the complex circuit diagrams of an electronic system. Even an ecological system consists of many different factors to form a complex infrastructure. Ecological systems are resilient and robust if they are not continually disrupted. In all these natural science cases, complex systems can be simulated through mathematical models and computer systems in order to derive explanations and prognoses.

Since at least the 1990s, the term “Systems Engineering” has become commonplace in the engineering field. Even as early as the 1950s, the ingenious American engineer Jay Wright Forrester (also pioneer of the RAM memory) had established a mathematical and computer-based system theory with which, for example, industrial processes and city infrastructures could be designed for the first time. Forrester became well-known in the 1970s for his first ecological models for the Club of Rome.

Around this time, the first software tools in IT to model and simulate complex engineering projects were developed, including Unified Modeling Language (UML). UML is a graphical modeling language for the specification, construction and documentation of software parts and

other systems. Project managers can use this to verify system requirements which business analysts have modeled in UML. Software developers realize workflows that business analysts have described in UML in collaboration with specialists. System engineers install and operate software systems based on installation plans that have been designed in UML.

A further example of systems engineering is Quality Function Deployment (QFD) which Toyota has used since the 1980s to conceptualize, create and sell customer-oriented products and services. QFD makes this possible by integrating quality control across all company departments.

In 1990, the National Council on Systems Engineering (NCOSE) was established in the United States, and then expanded to the International Council on Systems Engineering (INCOSE) in 1995. It is concerned with common standards for the education of system engineers who distinguish themselves through interdisciplinary abilities and who should follow a holistic approach in their problem solving.

But how can not just individual manufacturing processes but also complex systems become automated? This is the challenge of Systems Engineering today when it comes to automation of factories, housing and infrastructures. In IT, we talk of cyber-physical systems. One example is an airport where various domains need to be coordinated into a software. Here, there is not only the technology domain (e.g. aircraft), but also the baggage logistics domain and, ultimately, the passenger domain. Each of these domains

is defined by different semantics. These must be coordinated and common standards and protocols developed. This example makes the complexity of the demands on System Engineering very clear: the model is not only about technical and economical parameters. Cyber-physical systems require people (such as the passengers in our example) to be integrated.

## **AUTOMATED ENGINEERING AND THE FUTURE OF INDUSTRY 4.0**

The most popular application of a cyber-physical system today is the Industrial Internet (Industry 4.0). The Internet of Things, where objects and devices of any kind communicate via sensors, will now extend to production and machine parts. So it is not just about communication from person to person or person to machine but communication from machine to machine. This is the point where automated engineering meets Cognitive Systems Engineering. Scientifically speaking, Cognitive Systems Engineering deals with the interface between cognitive psychology and systems engineering: how do humans master complexity and how much of it can be automated, and so delegated to machines and software? Where do the strengths of humans lie? At its heart is automating the human-machine interface (HMI).

But Industry 4.0 isn't a doctrine of salvation nor a button that switches German Industry to full automation overnight. It will be much more about the various levels of automation which are differently set up in each company. Therefore, automated engineering should be affiliated with requirement engineering: the exact requirements and demands of an engineer within the complex processes of a company need first to be recognized and defined. This is a process which in some cases may take several months. Normally, external automated engineering experts need to be brought in to work with employees over a longer timeframe, in order to recognize the weaknesses and possibilities for improvement.

The corresponding business model is called "Buy and Build". A typical mid-sized industrial firm would bring in a company which is specialized in software and automation questions and can develop a fitting automation model into its production operations over a long period of time. In the end, in some cases, Industry 3.2 or 3.6 could become an efficient (and more cost-effective) solution.

Automated engineering thereby grounds such noble concepts as Industry 4.0 through the detailed application of automation, on site and in real operations. Specialized companies such as COPA-DATA should, however, not simply collaborate with business. Just as significant is cooperation with science. In COPA-DATA's case this includes working with the Chair of Food Packaging Technology at the Technische Universität München. Research can allow standardized and consolidated use of operating data and the calculation of the key figures necessary to assess the automation interfaces or for a detailed error analysis on site. Institutes of the Fraunhofer Group are also participating in this research. In the end, even our skeptical mid-sized company should be convinced that our most promising future lies in a stronger cooperation with automated engineering.



### **ABOUT THE AUTHOR:**

Prof. Dr. Klaus Mainzer holds the chair for Philosophy and Theory of Science at the Technische Universität München (TUM) and concentrates primarily on the fundamentals and applications of complex systems, artificial intelligence, the Internet of Things and Big Data in nature, technology and communities. He is the author of related books on these topics, such as: "Die Berechenbarkeit der Welt. Von der Weltformel zu Big Data" C.H. Beck, Munich (2014), "Künstliche Intelligenz. Wann übernehmen die Maschinen?" Springer, Berlin (2016)<sup>1</sup>. He is the founding director of the Munich Center for Technology in Society (2012-2014) and headed the Carl von Linde-Akademie (2008-2015) at the Technische Universität München.

<sup>1</sup> These books are not available in English translation at the current time, only in the German original.



## An Interview with COPA-DATA CEO Thomas Punzenberger

PHOTOGRAPHY: EVATRIFFT.COM

# AUTOMATED ENGINEERING WITH ZENON - WHAT'S IT GOOD FOR?

### **Why are zenon and automated engineering such a good match?**

The zenon philosophy is designed to fundamentally support efficient and error-free engineering. An important basis of this philosophy is “setting parameters instead of programming”. This makes it possible to configure projects without the need for individual programming. At the same time, zenon provides everything that is required in order to play an active or passive role in the automation chain. The consistent object orientation and the centralized approach in zenon are also important here. As are the openness and the interfaces of our software. Automated engineering draws on all of these principles and consistently leads the zenon philosophy forward.

### **Does this mean that automated engineering is already an established “feature” of zenon?**

Exactly; automated engineering has been a fundamental part of zenon for more than ten years. Over this time, we have significantly enhanced its capabilities and, meanwhile, the concept has become very powerful.

### **Who can profit from automated engineering?**

First, one has to say that the scope of automated engineering with zenon is vast. It starts with simple wizards and goes as far as generating large, completely automated projects. Essentially, anybody who creates zenon projects can profit

from automated engineering. But it is mostly of interest to machine builders and system integrators.

### **What is exciting about it for a machine builder?**

It begins with the integration of upstream engineering systems, in which machines and equipment are planned. Configuration files from these systems are used, in order to generate automated projects with zenon and this not only results in a huge time-saving, it is also helpful in avoiding errors.

### **Machine builders see a trend towards increasing individualization of their equipment. Does automated engineering play a role in this context too?**

Yes, a very significant one, actually. End customers are less and less content with equipment “off the shelf” and are increasingly likely to demand tailored configuration to meet their individual requirements. This naturally then also affects the visualization. Projects must be individually compiled for each plant. For complex facilities, it would no longer be possible to achieve this by means of manual engineering. Automated engineering solves this problem.

### **How exactly does it work?**

The equipment configuration for the end customer begins on the commercial level and can then be, for example, derived from the ERP system via a planning system directly

adopted by zenon in order to generate each individual zenon project automatically. The large amount of complexity which the individualization of equipment brings with it is thereby made manageable.

This means not only creating projects quickly and simply – through automated engineering – but also accurately. This is very important, because searching for errors later on is not only complex and painstaking, it can also, in the worst case, even delay the approval of the machine. This consumes manpower and capital. The advantages of automated engineering with zenon then has a direct effect on profitability and cashflow when machines are sold highly individualized but can still be rapidly and cost-efficiently handled.

For projects that are given a fixed price, the advantage is even clearer. Here, every minute saved in the engineering phase positively affects the integrator's margin.

**Are speed and efficiency the only advantages for integrators?**

Not entirely. In addition to the time-savings, as for a machine builder, a decisive advantage comes from the fact that errors are avoided. Projects or project parts that are created in an automated manner are reliable and repeatedly error-free. Many errors can therefore be avoided from the start, which in turn is an economic advantage. Particularly in the project completion phase, error correction can often be tedious and expensive for the system integrator.

---

*“Automated engineering has been a fundamental part of zenon for more than ten years already. In addition to the time-savings, a decisive advantage comes from the fact that errors are avoided.”*

**THOMAS PUNZENBERGER, CEO, COPA-DATA**

---

**What does automated engineering mean for a system integrator?**

zenon is designed to save engineering time. Automated engineering is on exactly the same track. Automated processes during project creation simply save a huge amount of time.

**Normally, a system integrator makes a living out of selling hours. Why would automated engineering still be interesting in this context?**

In fact, some system integrators today still place too little value on efficient engineering. Global competition, however, puts end customers under permanent pressure in terms of both time and innovation. Therefore, end customers are increasingly acquiring project know-how by training themselves in order to reduce the cycle times of their automation projects. Furthermore, they want well-constructed and transparently-developed projects that allow for changes in the long-term. Projects that are automated offer these positive properties as a further advantage because they can be managed without code or special solutions.

Innovative system integrators recognize that they can only achieve long-term customer satisfaction if they can deliver their projects more quickly and better than the competition. This is where zenon can add value as a long-term success factor.

**Meanwhile there is a new version of zenon available every year. Is more to be expected in terms of automated engineering in the future?**

Definitely. Even though with zenon we are already leading the way in this area, our ambition makes us keen for further innovation. Each new zenon version will bring additional innovations in the area of automated engineering.

**Finally, what advice would you like to pass on to our readers?**

Anyone who wishes to be successful in these times of the Smart Factory and Industry 4.0 cannot get around automated engineering. Use it to your advantage – not only in terms of the technology of zenon, but you can also profit from the know-how of our experienced technical experts. Talk to us!

---

THE INTERVIEW WAS CONDUCTED BY  
PHILLIP WERR, MARKETING MANAGER  
AT COPA-DATA.

PROJECT "DIMA" - NEW PATHS IN PROCESS AUTOMATION:

# Modular Applications for Customizable Production



Individuality, modularity, simplicity and efficiency need not be contradictory. In the “Decentralized Intelligence for Modular Applications” (DIMA) project, WAGO, together with COPA-DATA and other partners, prove how automated engineering and re-engineering can revolutionize process automation.

Fluctuating procurement and sales markets, flexible relocation of production sites and the increasing need for customer-specific individualization of a product range are leading to ever-shorter product and innovation cycles in the process industry. Conventionally-constructed process technology equipment in the areas of chemical processing, food and beverages, cosmetics and pharmaceuticals are usually not flexible enough and cannot efficiently master the introduction of new products or amended production quantities. Companies in the process industry often introduce new technologies with significant delay. The requirements are increasing: machines and equipment must allow for quick adaptation, in a modular manner and with minimal effort; production processes must be as flexible as possible in order to remain competitive. As part of the Industry 4.0 concept, the call for increased individualization, down to a batch size of 1, is getting louder.

#### **DIMA - PROJECT AND OBJECTIVES**

“DIMA – Decentralized Intelligence for Modular Applications” was initiated by WAGO, a global provider of electrical connection and automation systems. The project meets the demand for individualization of process equipment and a high degree of modularity in the automation of production processes.

more than 20 companies involved in the project – including COPA-DATA with zenon as process control system. Further partners are, among others, Emerson, Yokogawa and Endress+Hauser as manufacturers, as well as BASF, Bayer and Sanofi Aventis as users. Higher education partners are the Dresden University of Technology, the Helmut Schmidt University Hamburg and the RWTH Aachen University.

#### **SERVICE-ORIENTATED ARCHITECTURE WITH SMART EQUIPMENT MODULES**

Conventional process technology equipment is controlled by a process control system that includes process control, HMI and engineering. Part-modularized, process technology equipment often consists of a central communication and automation architecture (central intelligence), as well as process technology modules, such as centrifuges, agitators, filling machines, tempering or fermenting equipment. The idea of the DIMA concept is to compile an entire plant consisting of several autonomous equipment modules. An equipment module displays one or more standardized process steps, carries out procedures, operations or functions and thus provides a so-called service. The module manufacturer defines whether a service creates an interim product in a complex module, for example, or whether a service operates two valves and a pump. A

---

*“Our aim is to considerably shorten the time between product approval and market availability. We estimate that 60 percent of the development time of process equipment can be saved. But this can only happen if the equipment is created in a modular manner and we give the company the possibility to act more quickly and flexibly.”*

**ULRICH HEMPEN, MANAGER OF INDUSTRY & PROCESS MARKET MANAGEMENT AT WAGO**

---

DIMA was first presented at the annual general meeting of NAMUR in 2014. NAMUR, the international User Association of Automation Technology in Process Industries was founded more than 65 years ago. The DIMA concept is based on a standardized approach of NAMUR’s 1.12 working group. The committees of NAMUR and the German Electrical and Electronic Manufacturers’ Association (ZVEI) have now taken on this approach in order to further specify it. The objective of the cooperation is the development of an international standard. WAGO was looking for partners to help position the concept on the market and to secure high acceptance and wide market penetration with providers and customers. There are now

module provides its process-technology function as a service to the higher-level process control system – it takes on the role of a service provider. The process control system can call up the service offered by the module – it acts as a service user. DIMA consequently uses the paradigm of service-orientated architecture (SOA), which is proven in the IT field. The modules have their own “intelligence” in the DIMA concept. Each module is equipped with its own controller, which executes services and monitors the module status.

The engineering of the overall equipment is based on two independent engineering processes: the module supplier first configures the module (module engineering)

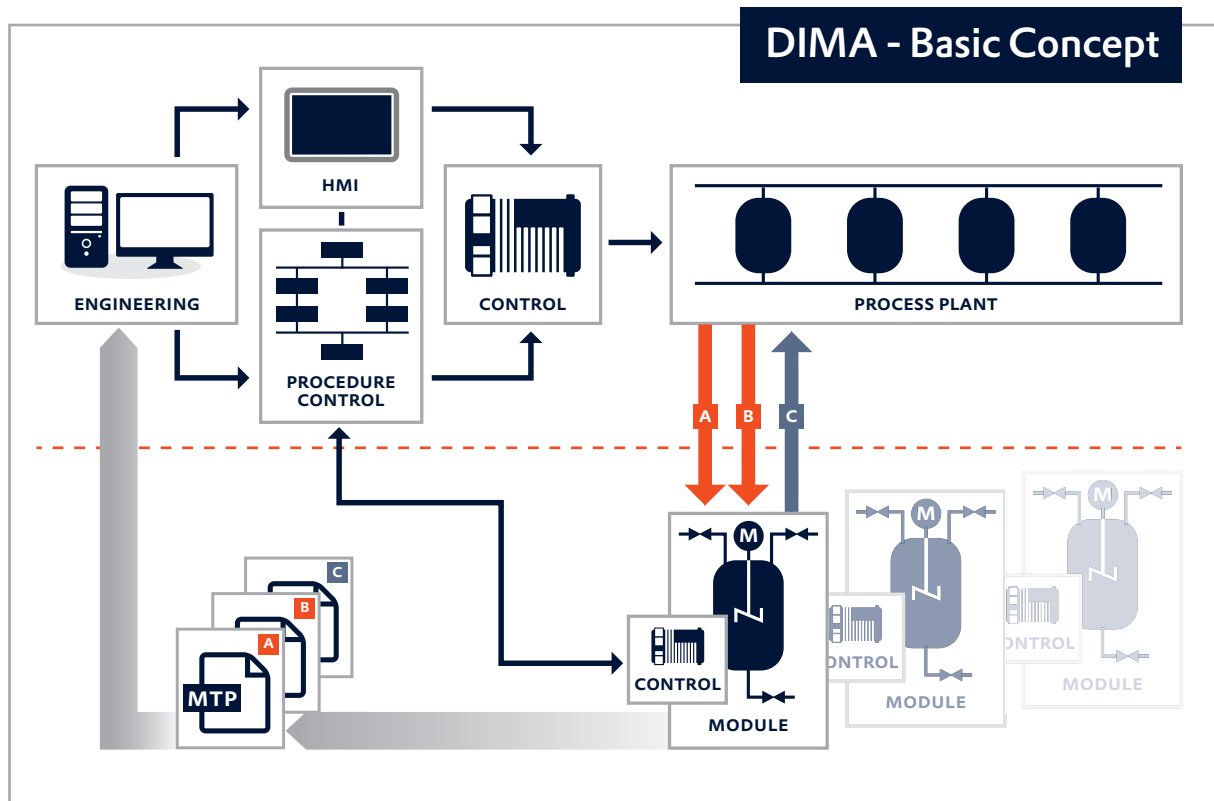

and provides a description. The equipment operator uses this description in the integration engineering and configures the entire plant.

If companies wish to amend a production process, they only need to exchange one or more modules. The production quantity can be increased by means of numbering-up, i.e. adding modules of the same type. The major benefit of the modularization of equipment is the reduction in engineering work. Manufacturers can plan and construct modular equipment more efficiently, because a large part of the engineering can already take place in the module engineering phase. The modules that are already fully automated only need to be integrated into the process control system.

#### TECHNICAL MODEL AND STRUCTURE

The technical implementation of the DIMA method requires a new definition for the description of process equipment modules: the "Module Type Package" (MTP). The following information is stored in this MTP: communication parameters for easy integration of the module into the equipment; services, i.e. the description of the process performance characteristics of the module, as well as

graphics information for operation and observation. In addition, there are further descriptions, such as information on status, diagnosis, history and archiving.

In order to design the complete engineering or re-engineering process as efficiently as possible, WAGO and COPA-DATA have developed an MTP handling and management system. With this system, companies can read in the MTPs and trace which artifacts in zenon have been created by which MTP. This allows the connection of the modules required in the process, even in ongoing operation. zenon also gives customers the possibility to select and export customized services and operating screens. This way, companies can set out a concept for reuse and reduce project-related costs.

#### UNIFORM VISUALIZATION

As part of DIMA, the MTPs are not provided with any graphics data, but only the information that something (such as a temperature for example) must be displayed. The process, distributed over several modules, is to remain operable and observable. zenon is used for this. The central challenges in the process are the automatic creation of operating screens and the implementation of

a uniform look and feel of the modular equipment. The module manufacturer is responsible for the planning, the construction and the programming of the module, and therefore creates the operating screen of the module. At this time, the creator still lacks the knowledge of the operating screen library of the higher-level system. However, a function (such as the display of a temperature) must always be displayed identically in the control system. To translate the module-specific operating screens into a uniform look and feel in the project, the operating screens must be available in a display-independent specification form. This contains information regarding the operating screen element, as well as its location and size. An algorithm sets the project-dependent operating screen elements in the desired display and location on the operating screen of the target system and links them to the corresponding variables for communication with the PLC of the module. The use of this role-based library concept means that the library is present in both the engineering tool of the module manufacturer as well as in the target system. A corresponding library is currently being developed by NAMUR and ZVEI.

### THE INTERACTION OF THE SERVICES

To process the individual production steps, the services of the modules must initially be put into an ordered sequence. A continually-operated reaction process requires, for example, coordinating the start-up of the reactor with the provision of the initial products. In order to orchestrate services throughout modules, companies must be aware of the current status (such as run, stop or error) or status transitions. The decentralized intelligence of each module determines the corresponding information and transfers it using a communication interface. In order to bring the services of the connected modules into the desired sequence, DIMA envisages the use of batch functionalities (zenon Batch Control module). The range of functions of a production plant is visualized in the batch tool with the help of several models. The module communicates with Batch Control directly and receives the command to execute a service from there. If the module has completed the execution of the service correctly, it reports this as a status.

### FIRST PROTOTYPE EQUIPMENT

At the SPS IPC Drives 2015 trade fair in Nuremberg, WAGO presented equipment that meets all requirements of NE 148 and similar standards for the first time. The prototype DIMA equipment consists of four modules that each form a typical process technology step: mixing, distilling, filtering and bottling. In the process, two reactants are mixed in the mixing station, their product is then separated

by distillation and the distillate is then filtered when coagulation occurs and then filled into manageable vessels. All four modules are equipped with their own intelligence – the PFC200 controller from WAGO. Each have an MTP and are connected to a backbone in a star shape. This supplies the modules with electrical energy and compressed air to operate the actuators. In the integration engineering, the MTP is integrated into zenon with the help of a wizard, which displays all MTPs that have been read in and deletes them again if required. The operating screens are then created automatically. The production process is shown as a recipe and the individual recipe stages include possibilities to set parameters.

WAGO – together with COPA-DATA and other partner companies – are using DIMA to forge new paths in process automation. Users will thus be in a position to implement flexible process equipment in a short time, reduce product cycles, react more quickly to new market conditions and individualize their production.



THOMAS HOLM,  
GLOBAL KEY ACCOUNT MANAGER,  
WAGO

PHILIPP SCHMIDT,  
BRANCH OFFICE MANAGER,  
COPA-DATA GERMANY





# PRODUCTS

# &

# SERVICES

# NEWS FROM THE CURRENT ZENON RELEASE

THESE NEW FEATURES ARE SURE TO MAKE YOUR  
ENGINEERING LIFE MUCH EASIER!

The COPA-DATA team constantly does all it can to make the world of industrial automation more ergonomic. With the releases of zenon 7.50, zenon Analyzer 3 and zenon Logic 9, numerous new features and improvements have been added which continue to reinforce this initiative. Many minor and major innovations make life easier for the user.

Keep an eye out for these six highlights:

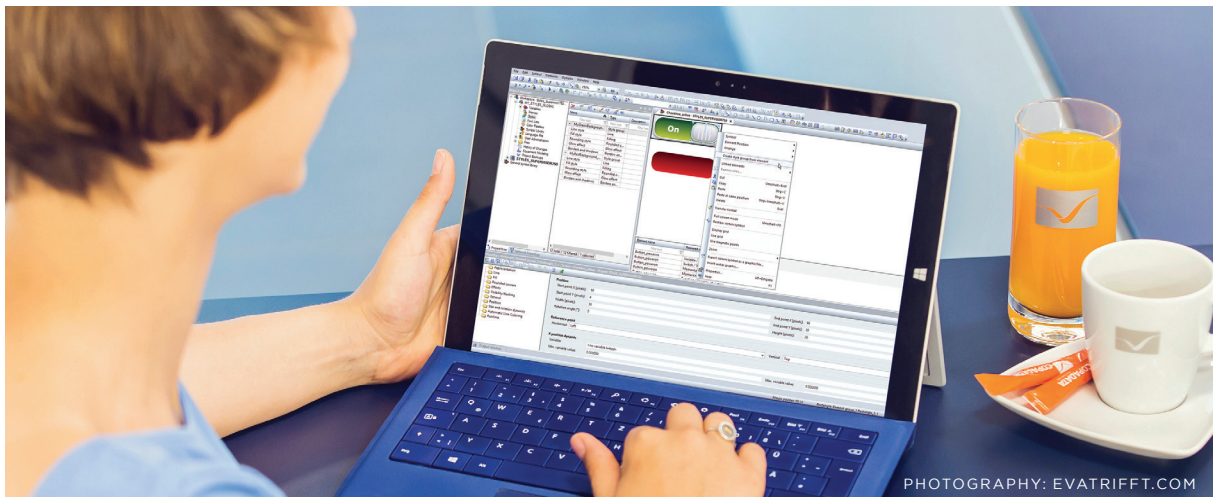

PHOTOGRAPHY: EVATRIFFT.COM

## **STYLES:** THE ERGONOMIC WAY OF CONFIGURING PROJECTS

Styles compile graphic properties of screen elements in zenon. This means that you can define graphic parameters such as line width, size, color, etc. for the required elements. These styles, saved in a global project, can then be very easily transferred to all other elements. This ensures that the design remains consistent in a project – or even throughout different projects. All at the click of a mouse!

And if the appearance of elements needs to be changed? Then simply amend the styles centrally. The linked elements automatically change too. This guarantees a consistent look & feel, even with multi-user projects. The central maintainability of the elements ensures easy reuse and quick and ergonomic project configuration.

## **MESSAGE CONTROL:** VOICE OVER IP AND NOTIFIER APP

With the integration of “Voice over IP” in Message Control, the module was given the most up-to-date technology for sending messages.

The Notifier App, available as an Android app in the Google Play Store, is an addition to the zenon Message Control module. The app detects alarm messages that have been sent via Message Control as an SMS. It offers a graphic interface for easy acknowledgment of alarms on a smartphone. You can react to alarms quickly, regardless of where you are.

## **BATCH CONTROL:** XML EXPORTS AND IMPORTS OF RECIPES

Until now transferring batch recipes from one project to another was – admittedly – somewhat cumbersome. With

the enhancements in zenon 7.50, a major step in usability has been achieved here: recipes in the zenon Batch Control module can now easily be transferred from one project to another by means of XML export/import, or edited with external tools.

### **MAJOR NEW FEATURES FOR THE ENERGY INDUSTRY: COMMAND INPUT WITH THE COMMAND SEQUENCER**

Our customers in the energy sector will noticeably increase their productivity with the new Command Sequencer module. It simplifies the configuration and setting of command sequences considerably. The users themselves can now, intuitively and without programming knowledge, compile sequential function charts for commands, test these and apply them. The same also applies for changes and command sequences.

The project is configured in a graphic editor in Runtime, either by selection and compilation of the individual steps or by means of "teaching". With teaching, the system learns command sequences. The user carries out the switching operations directly in the single-line diagram and the command sequence editor records the switching actions independently. In addition to the ease of use, a further advantage of this procedure is that possible errors are prevented in the first stage of project configuration. All operations are, of course, subject to zenon user management. This clearly defines who can create, operate or change command sequences, and in which manner this should be done.

### **HTML WEB ENGINE:**

#### **NEW MOBILE APPLICATION POSSIBILITIES**

With the HTML Web Engine in zenon, dashboards can be easily displayed using the browser. The HTML Web Engine is thus another possibility for accessing zenon using mobile devices. The screen needs only be drawn once in the zenon Editor and can be displayed directly as an HTML5 image. This means that, even with projects that use the HTML Web Engine, only one central engineering tool, namely the zenon Editor, is required.

### **ZENON ANALYZER 3**

For users of zenon Analyzer, it is immediately evident that there is an important new feature that has been unveiled in version 3: the Report Launcher, used to display reports in the web-browser, has been newly designed. The clearer design of the user interface ensures better usability and the enhanced browser support offers more flexibility.

zenon Analyzer 3 also provides new reports. The efficiency classes report, for example, expands on functionalities in the area of energy data management. In addition to many further new reporting possibilities (CEL reports, report with dynamic normalization etc.), line management is a focus of the new product version. The new line analysis allows reporting for the complete production line on the basis of batches. A batch can thus be transparently traced throughout the complete production line, tracking all losses and interruptions.

The basis of a meaningful analysis is the database that lies behind it. zenon Analyzer 3 uses the latest technology for this and is supplied with Microsoft SQL Server 2016. In addition, cloud storage can also be used natively with the connection of Azure SQL

## **FAST FACTS**

These new features also await you:



- S7 TIA direct driver for communication with the Siemens TIA portal
- IEC 61850 Edition 2 certification
- Improved Scheduler interface
- Performance improvements, especially for large projects with comprehensive variable lists
- Usability improvements
- More precise forecasts for load management
- Enhancements to metering point administration
- Incorporation of zenon Logic 9
- Enhancements to the HTML Web Engine



- Implementation of current security technologies
- Usability improvements for the zenon Analyzer wizard
- Manual data editor enhancements, including increased user-friendliness
- New and revised analyses of hydroelectric power plants
- Reports with weather adjustments
- Enhancements to "Extended archive analysis"
- Azure SQL Database integration

# IN OR OUT?

THIS IS HOW YOU CAN FIND OUT WHETHER YOUR C# CODE WOULD PREFER TO EXIST IN ITS OWN APPLICATION.

**It's always the same question: VSTA, ActiveX, .NET control or perhaps an EXE after all? So, we'd like to give you some new food for thought and criteria for making the best decision.**

First things first: whether program code is best executed within the main application or as its own process depends very much on the particular case in question. There is no single rule for this. This article shows the differences, as well as advantages and disadvantages of both variants.

In principle, we distinguish between two types of code during considerations: code that is executed within the same process and that which is executed in a separate process.

The first type includes VSTA, ActiveX, .NET controls and all other variants whereby your code is loaded into the main application as DLLs. In this case, the main application and your code share the same virtual address space and use the same main thread. Mutual calls between your code and the main application are normal assembler calls, without overhead, so to speak.

If your code runs in a separate process, it has its own virtual address space and its own main thread completely to itself. It thus runs at the same time and completely disconnected from the main application – generally even on a different processor core. Mutual calls between this code and the main application do, of course, entail much more work, because it concerns a communication between two processes, the so-called interprocess communication. This means that each call beyond the process limits takes a relatively large amount of time. COM is generally used as the interface on Windows operating systems. The interprocess communication with COM works internally by sending Windows messages to hidden windows of the other application. A call can therefore even take up to a millisecond and is very dependent on system load. In principle, this speed disadvantage also applies to any other

interface suitable for interprocess communication and is even more pronounced in most of them (sockets or pipes for example). A major advantage for the developer is that COM works exactly the same, regardless of whether it is used on an intraprocess or interprocess basis.

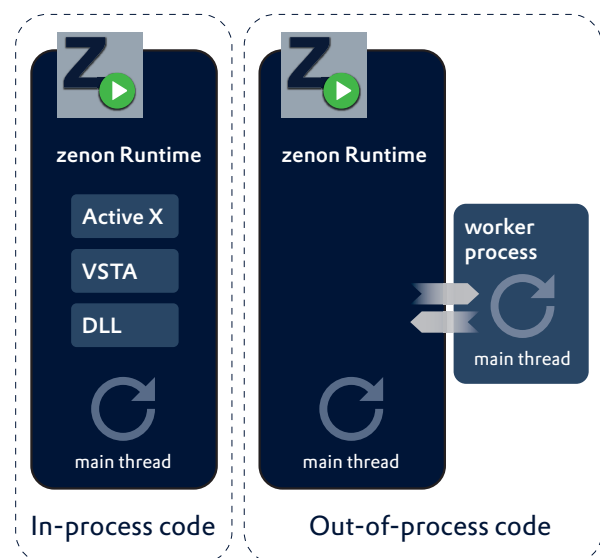

## THE ZENON API

In the case of zenon, the complete zenon API is implemented as a COM interface. It can also be identically addressed by the same C# code – regardless of whether this runs within or outside of zenon Runtime. As a result, it is also not a problem if you only decide on the other variant later on.





In addition to the issue of how it works in runtime, there are other areas where differences occur. The following table provides an overview to help you in the decision-making process:

**AN OVERVIEW OF AN EXTERNAL APPLICATION:**

	
+ Code requiring intensive computing power runs on its own processor core without additional effort.	- Calls in the main application (API) and from the main application (events) take a long time.
+ 32 bit applications have the full addressing space available.	- The application must be able to react to the closing of the main application and changes to the configuration of the main application, with restart functionality if necessary.
+ As many .NET versions and third-party applications as desired can be used.	- The application must be deployed separately on the target system.
+ Worker threads can use the zenon API directly because COM transfers the thread switch to the single-threaded zenon API.	- Visual Studio is required.
+ Debugging a small, encapsulated application is simpler.	

**AN OVERVIEW OF INTERNAL CODE/VSTA:**

	
+ Calls in the main application (API) and from the main application (events) do not take any time.	- Your code runs in the same main thread, thus slowing down the main application.
+ The application can automatically be deployed on the target system with the main application (via zenon Remote Transport for example).	- Worker threads must programmatically take the single-threaded architecture of the zenon API into account (using Delegate for example).
+ VSTA-IDE is integrated into zenon, so a separate Visual Studio is not required.	- 32 bit applications share the address space with the main application.
	- The.NET version is prescribed by VSTA.

**MAKING A DECISION**

If there is no knockout criterion in deciding for one or the other, we recommend comparing the number of mutual calls and the processing intensity of your code with one another. If many API calls and events are expected, internal code (such as VSTA) will be able to play on its performance strengths. If your code requires a lot of computing power, is memory-intensive and complex, but is rather loosely connected to the main application, then an external application has significant advantages when it comes to side effects, scalability and freedom of development. It

is important in each new case that you ask yourself the question: in or out? Sometimes it can even make sense to execute a part of the code in zenon Runtime and another part as a separate process. There is no patented recipe for this, but zenon can competently support you with both variants.

---

GÜNTHER HASLAUER,  
DEVELOPMENT MANAGER

KICK-OFF A NEW PROJECT LIKE A PRO:

# How Schweitzer Engineering Laboratories Capitalized on Ergonomic Engineering with zenon

When a new automation project gets kicked off, there are many important decisions that must be made. Often people jump right into the SCADA development without first understanding the main design and development challenges that are ahead of them in the next several weeks or months. This is a critical time period in which one seemingly harmless decision can be the determining factor on whether a project is delivered on time, meets a budget and is within specification or whether it will be late, sloppy and prone to errors.

Let's take a recent example in which COPA-DATA collaborated with Schweitzer Engineering Laboratories (SEL) to deliver a large substation automation solution.

## **THE CHALLENGE**

Our main task was to work with the SEL engineers in the design phase of their SCADA projects. After some discussions on communication protocols and drivers, we took a detailed look at the zenon variable or tag creation process. In zenon, there are quite a few ways to create process variables or tags.

On the one hand, variables can be created manually, one by one. But this method is often prone to human error and can be quite time consuming. Therefore, we ruled this option out quickly. For some specific drivers, zenon offers the ability to import the variables via Online or Offline

modes. For smaller projects, this is a gigantic time saver. The driver Online/Offline import could theoretically import all tags for one specific device in less than ten minutes. However, this option was also ruled out because the devices were already in the field, operational, and a few continents away from us. The other disadvantage here is that this import would result in a flat, unstructured list of variables. Another option we considered was a CSV import. zenon also offers a CSV import option to allow for the creation or modification of variables based on a CSV definition file. This is a common approach, and it is a nice way to make bulk changes very quickly. However, due to the size of

State	Name	Description	IEC data type
	2411.AI	2411 Analog Inputs	
	IA_Mag	Structure element	DINT/<embedded> 1
	IB_Mag	Structure element	DINT/<embedded> 2
	IC_Mag	Structure element	DINT/<embedded> 3
	IN_Mag	Structure element	DINT/<embedded> 4
	Freq	Structure element	DINT/<embedded> 5
	VAB	Structure element	DINT/<embedded> 6
	VAVG	Structure element	DINT/<embedded> 7
	VBC	Structure element	DINT/<embedded> 8
	VCA	Structure element	DINT/<embedded> 9
	VN	Structure element	DINT/<embedded> 10
	Q	Structure element	DINT/<embedded> 11
	P	Structure element	DINT/<embedded> 12
	PF	Structure element	DINT/<embedded> 13

Figure 1: Setup of structured datatypes for the SEL-2411 Programmable Automation Controller.

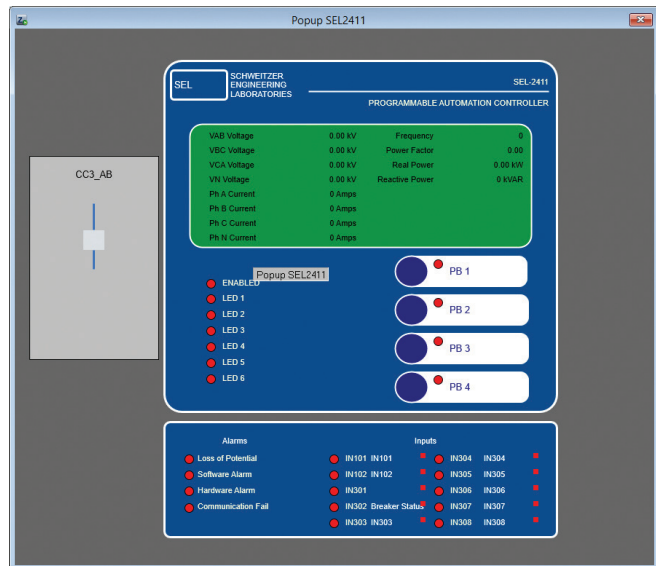

Figure 2: An SEL-2411 popup screen, showing live data from the device.

this project and the fact that several engineers would be simultaneously working on the zenon project, it was foreseeable that each engineer would use slightly different methods during the CSV export, modification, and import which could potentially yield inconsistent results.

### THE SOLUTION

Finally, we came to our solution – zenon datatypes: an object-oriented method of creating variables which ensures consistency and supports inheritance. In the electrical system of this specific substation automation application, there are hundreds of instances from about a dozen different SEL IED types. By using structured variables in zenon, it was possible for us to create one datatype for each device type. The initial time invested in setting up the datatype with appropriate objects and properties is quite small compared to the time savings and organization gained as a result of its use.

For example, we set up structured datatypes for the SEL-2411 Programmable Automation Controller as shown in Figure 1. Since every SEL-2411 is configured with identical DNP Maps, we were able to even go so far as to set at the datatype level all of the alarm and event conditions, identification labels, control properties, as well as the DNP addresses.

Once the structure is created, it can still be enhanced or modified later, even if variables (instances) were already created based upon it. For example; to add an alarm to the existing structure element 24.11AI.PF at the datatype level, all instances of this type will inherit this modification automatically.

### BUT THIS WAS JUST THE BEGINNING ...

While leveraging the benefits of zenon’s datatypes, we pushed the object-oriented concept a step further to include the topic of popup screens. In this system, one faceplate or popup screen for each device instance was planned. If a user clicks on the SEL-2411 from the online screen, an SEL-2411 popup screen will be displayed (see Figure 2), showing live data from that specific device. This is a common task in an HMI/SCADA system, but our goal was to accomplish this in the easiest, fastest and the most reliable way possible.

To start, we created a single screen in zenon for the SEL-2411. We set the frame to have a border so that it could be dragged around in the runtime, and set the frame so that it could be opened multiple times (e.g. to compare two separate SEL-2411 devices side by side). Then, by using symbols and native zenon screen elements, we created a 1:1 replica of the device. As a pre-condition, we had also created a set of “dummy” internal variables in zenon to act as an engineering side placeholder on the screen itself.

To visualize and represent the 100 different instances of the SEL-2411, we knew that we could use a single screen together with the zenon screen substitution, thus essentially replacing the variable linking behind the screen objects. This has been possible with zenon for many years now. However, up until zenon 7.11, in order to represent the 100 different instances of the SEL-2411 by using standard functionality, it would have been necessary to create 100 different screen switch functions, one for each instance.

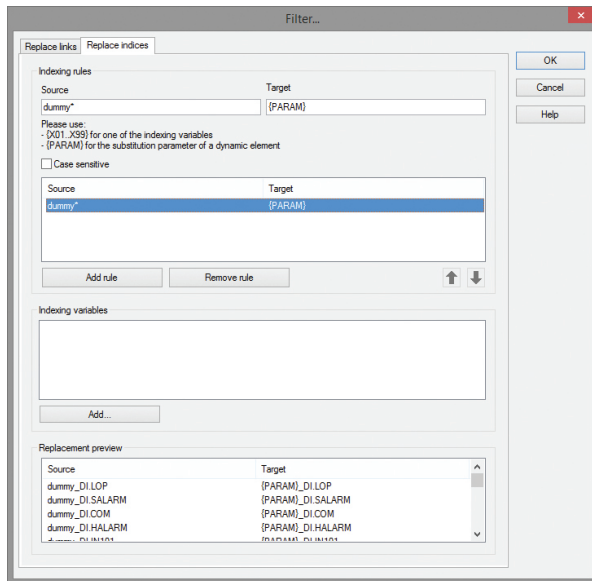

Figure 3:  
Based on the replacement rule – Source: dummy\* / Target {PARAM} – in the screen switch function and depending on the button the user clicks, the correct variables are displayed in runtime mode.

### SOMETIMES, IT CAN BE THAT EASY

As we were using zenon 7.11 in this project, we were also able to take advantage of screen substitution with parameterization. What this eventually meant for us, using native functionalities, was that we could visualize the 100 different instances of the SEL-2411 device type by creating only one screen and only one screen switch function!

So how does this actually work, you may ask? Ok to start, based on our structure and following a naming convention, we created an instance variable called A1\_CC1\_AB\_2411, and to represent our second device, a set called A2\_CC1\_AB\_2411.

In the screen switch function, which opens the SEL-2411 screen, we visited the tab called “Replace indices”, where we entered the following replacement rule (see Figure 3):

Source: dummy\*  
Target: {PARAM}.

The contents of {PARAM} are filled during runtime, and this parameter is read from the calling element. In our case, this was the button which resides on the oneline screen. In zenon 7.11 and newer that button is linked to our single SEL-2411 screen switch function, but it also has a text property included for the parameter for substitution. That is where we entered the unique instance name in our example, either A1\_CC1\_AB\_2411 or A2\_CC1\_AB\_2411. In runtime mode, the correct variables will be displayed depending on the button the user clicks.

### ERGONOMICS WITH ZENON

This is just a small, but effective, example of how smart decisions made early on in the HMI/SCADA project design and use of supporting software can pay off many times over.

#### Video:

**You too can save time and money by using the ergonomic engineering functions of zenon as described in this case study.**

Scan & Play!

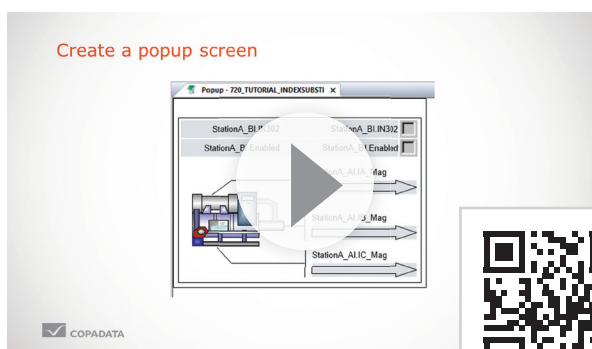

<http://kaywa.me/mZRO1>



LOUIS PAGLAICETTI,  
TECHNICAL CONSULTANT

SERIES: EFFICIENT ENGINEERING WITH ZENON  
PART 6

# Automated Engineering

What would a topic series entitled “Efficient Engineering”  
be without the topic of automated engineering?  
Anyone who has been familiar with zenon for a while knows  
that this is a standard “function” in our software.  
But what does this mean exactly?

TEXT: MARKUS HELBOK,  
HEAD OF TECHNOLOGY SERVICES

Automated engineering allows projects to be created partly or fully automatically. Depending on the application, this can happen by means of setting parameters in already existing wizards and tools, such as for the import/export possibilities of zenon Editor. Alternatively, however, zenon is controlled using scripts and macros or an external program, for which programming knowledge is required.

## **A LONG TRADITION OF AUTOMATED ENGINEERING IN ZENON**

Back in 1999, with the release of zenon 5, Visual Basic for Applications (VBA) was introduced in our software. Initially only for Runtime, in order to allow individual customer solutions for our standard product. Our CEO, Thomas Punzenberger, selected VBA because this programming environment, based on Visual Basic (VB) 5, was already sufficiently known from the Microsoft Office packages. The implementation was so successful that

Thomas Punzenberger was even invited by Microsoft to Redmond, to present the solution.

The integration of VBA was also a complete success for our customers and the wish for VBA in the Editor quickly followed. Two fundamental functions for automated engineering were ultimately integrated into zenon 6:

- VBA for the Editor
- XML export/import

The highlights of zenon 6 correspondingly included “automatic engineering” and “efficient reuse”. And this applies now more than ever. Intensive work has been dedicated to these issues in recent years. When VBA was no longer developed and .NET prevailed, we implemented Visual Studio for Applications (VSTA) in zenon – with the possibility to choose development in VB.NET or C#. In addition, we allowed XML export/import for virtually all zenon modules.

A tip at this point: the interface for VBA and VSTA is the same. With a few exceptions in the Multi-Touch environment, the same functionalities are available in VBA as in VSTA. There are, however, more possibilities outside the zenon interface in VSTA. First, a very large integrated scope of functions is available with the .NET framework 3.5 and second, VSTA supports multithreading.

In addition to VBA and VSTA, there is a third significant possibility for automation: an external program. In an external program, the zenon API is also available in full and can be used accordingly. The advantage of this option is primarily the free choice of the programming language. You can, for example, also use Java or other programming languages for your application.

## WHEN DO YOU USE AUTOMATED ENGINEERING?

Creating a program for automated engineering yourself is time consuming and requires specialist knowledge. You should thus first always ask yourself the question: manual or automated?

Reasons for choosing automation are as follows:

- Repeated tasks:  
For example, creating the same users, variables, functions etc. for each new machine
- Information is already available in digital form:  
For example, variables in external data sources or screen information that can be derived from the PLC program

- Results should be reproducible:  
For example, critical elements that should always be the same
- The task is so comprehensive that automation is beneficial:  
For example, creating 500 screens or processing 10,000 variables

Automation is worthwhile particularly when there are large amounts of data, the tasks are repetitive or certain data is already available electronically in databases or other systems.

This article does not provide instructions on how to implement customized automated engineering. However, we have suggestions and ideas for you, for how you can enter into the world of automated project creation, most of all for:

- Programming in VBA
- Programming in VSTA (C# or VB.NET)
- Programming in external software, such as Excel
- XML export/import

Yes, that's right: you can also easily program zenon from Excel – using Excel VBA. You thus have exactly the same possibilities as in zenon directly. It's very simple if, for example, you have variables in Excel and want to create these in zenon: you open the Excel table from zenon VBA or VSTA and read off the values. This is how the zenon Automotive Generator (zag) works, for example. On the

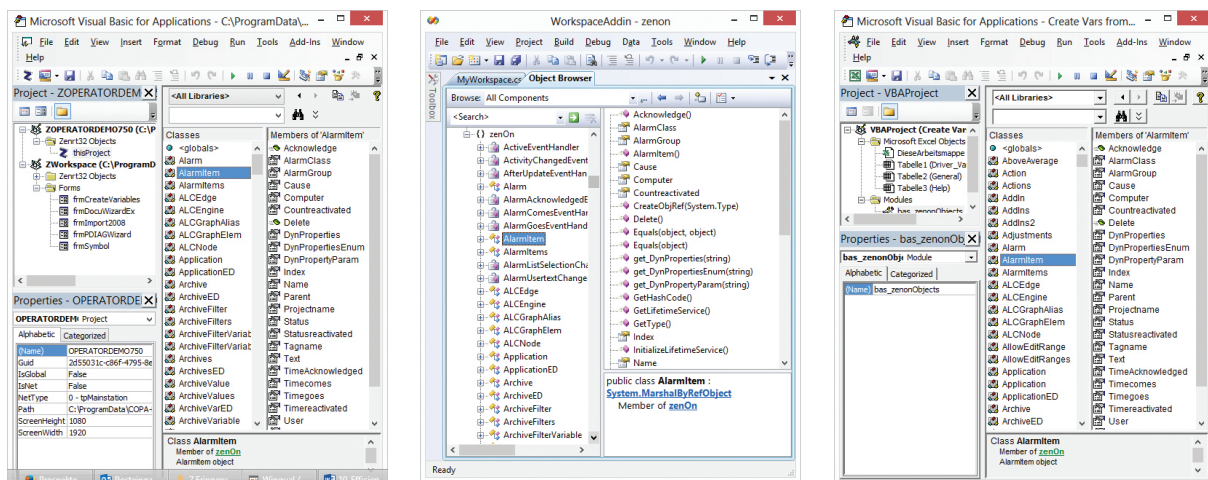

Figure 1: The zenon API in zenon VBA (left), in zenon VSTA (center) and in Microsoft Excel (right).

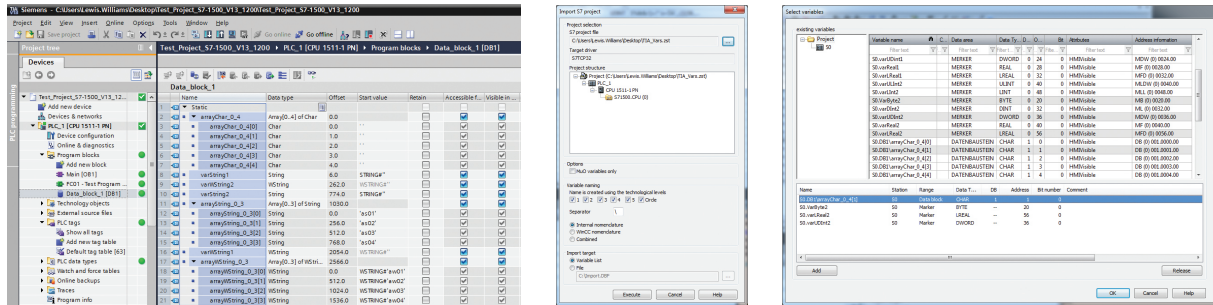

Figure 2: Import of variables from Siemens S7 TIA Portal.

other hand, you can also access the zenon Editor from Excel directly and create, modify or also delete zenon objects.

You have a range of entry points available to start your automation solution in zenon:

- Wizard
- Macro that is started from the macro toolbar
- Macro that is triggered by an Editor event. A very good possibility for starting actions fully automated. E.g. relevant events are triggered when loading a project or when a backup is created. However, it is also possible, when editing a screen for instance, to evaluate a double click on a screen element
- External program that is incorporated in the zenon main menu

**AUTOMATE WITH XML**

There are now four possibilities for editing variables in the zenon Editor:

1. Import via a driver:
  - For example, Siemens S7 TIA portal (see Figure 2), Allen-Bradley ControlLogix, OPC UA and many more.
2. Export/import in dBase format:
  - An old format that can still be used by Excel and Access.
3. Export/import in CSV (comma-separated text file):
  - This file format is particularly suitable for semi-automated engineering in Excel, where mass processing is often easier to handle than in zenon, for example when modifying addresses.
4. Export/import with XML
  - The following particularly speak in favor of this supreme method:
    - a. XML export/import is available for virtually all zenon modules.

- b. All data is exported (e.g. dBase and CSV only support four limit values).
- c. All files can be easily used with modern programming methods such as LINQ to XML.
- d. Very good performance.

Methods 2 to 4 (see Figure 3) are particularly well-suited to automation purposes, because they can be used to create, modify and delete variables (and also other objects with XML).

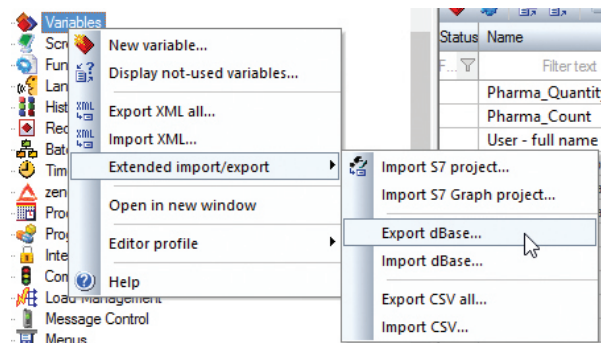

Figure 3: Export/import in dBase format, as CSV or as XML.

In addition to manual XML export/import, there is the particularly useful method of automating this process using the API. We even expressly advise doing this, because this way objects can be created or modified using the API directly. And with XML export/import, this usually works much more quickly because each object does not need to be handled individually.

We recommend the following procedure: export all existing objects by means of XML. Then carry out the necessary changes in the automation tool (for example, by LINQ to XML) and import the file again. A freely-available example in which the XML import is shown is the project wizard.

Another benefit of the XML method is that you can easily create and save templates with it. Two methods are available:

1. Create the corresponding objects (variables, screens, functions, scripts, recipes, users, etc.) once manually in the zenon Editor and then export these by means of XML into a template folder. This can also be automated if required. What is important for this is a uniform naming convention, for example when all templates start with the "tpl\_" prefix. This way, an automation tool can identify all templates and process them automatically.
2. With the screens, it is also possible to create templates using the screen template mechanism. The advantage in doing this is that the name, description, screen size and preview screen are included in the zip file.

### IDEAS FOR PRACTICAL USE

The most frequent application for automated engineering is surely use in conjunction with variables. Be it just transferring variables from other tools or issuing Modbus addresses, correcting driver configuration information or converting a driver to a different one, including manipulating address information. The large amount of data and the error rate of manual entries speak in favor of automation here.

A very exciting possibility is offered in conjunction with zenon Logic, our integrated PLC system. The user positions graphic objects in a screen, in the form of symbols. In the background, the variables and detailed screens (faceplates) are then created by a wizard and even the PLC code is created.

A further example in conjunction with zenon Logic is the metering point administration: when a metering point is created, the code to calculate the relative values is also created in zenon Logic.

Many machine manufacturers use automation to individualize their projects. Instead of offering all options in a large project where options that are not required are deactivated for each individual machine, the machine project is tailor-made from a modular system with a wizard. The individual configurations are then stored as

templates in XML format and are compiled as required. This configuration can also be carried out in part with external tools.

---

## EXAMPLES OF AUTOMATED ENGINEERING IN ZENON

### THE ZENON EXCEL MACRO

The zenon Excel macro was developed by COPA-DATA consultants and shows how easy it is to create drivers and variables in zenon from Excel. The example (see *Figure 4*) consists of an Excel table with its own macros and four buttons: the connection to zenon Editor is established with the first button; the second button provides all available projects; the drivers defined in the Excel table are created with the third button and the predefined variables are created in zenon with the fourth button. You can request this Excel file from COPA-DATA anytime.

### THE ZENON AUTOMOTIVE GENERATOR (ZAG)

"zag" is a very efficient example of automated engineering. You can find details about it in the article entitled "Generate projects in zenon automatically: zag – the wizard for the automotive industry" on page 45 in this issue of IU.

### THE PROJECT WIZARD

The project wizard is supplied with zenon and is automatically opened with each new project. It is programmed in C# and covers the issues described very well with:

- Direct modifications using zenon API: creating a driver for example.
- Import of existing XML files from stored templates: importing a demo project.
- Handling of screen templates (see *Figure 5*): zenon standard and user-defined screen template selection and import.

The wizard also shows how multithreading can be implemented. For example, this is how the zenon screen templates are read in their own thread. The wizard is VSTA-based and is available as source code.

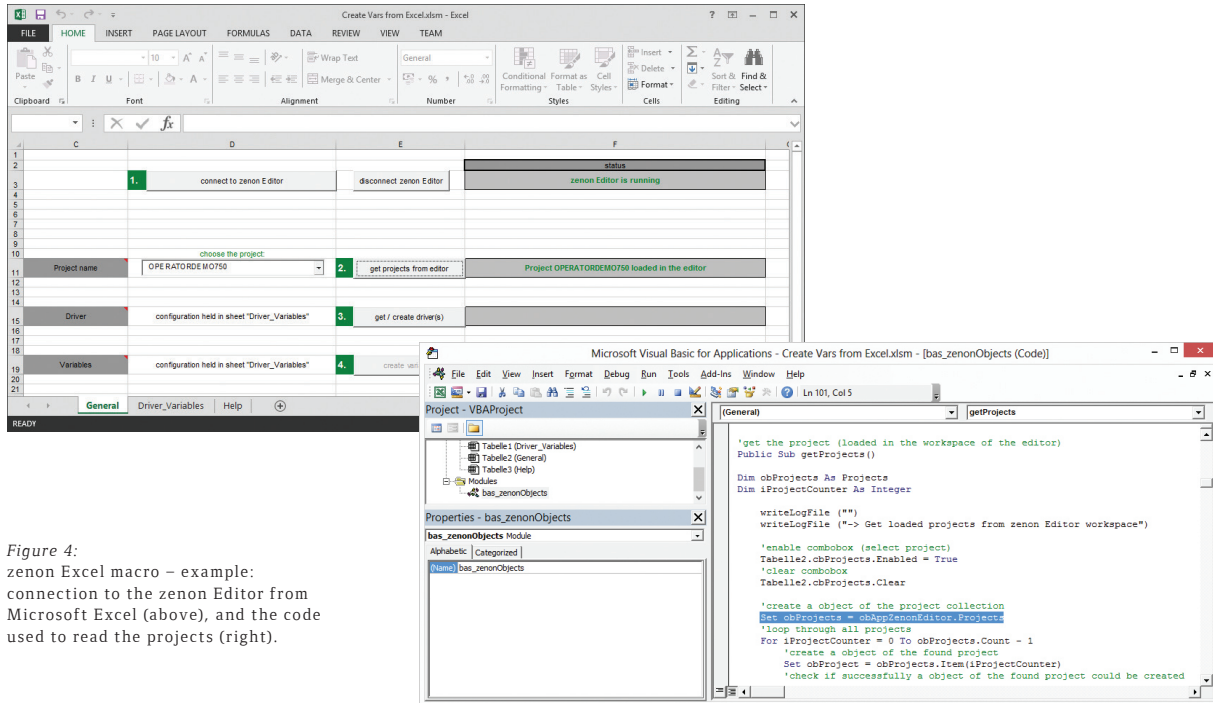

Figure 4: zenon Excel macro – example: connection to the zenon Editor from Microsoft Excel (above), and the code used to read the projects (right).

## CONCLUSION

With automated engineering in zenon, you have a powerful tool at hand; compared to manual engineering you can save a great deal of time in project configuration and provide a significant increase in accuracy and reproducible results. zenon does indeed offer many possibilities out of the box for efficient project creation. However, with automated engineering, these can be multiplied and efficiency can be increased accordingly.

We wish you much success with your automation projects!

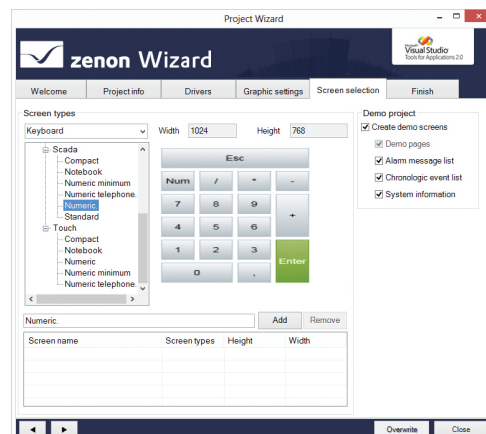

Figure 5: The screen selection for screen types in the zenon project wizard.

MINE, MINE, MINE!

# User-defined HMIs

Have you always wanted to look into a crystal ball and take a peek at the future? Somehow we are already in it. Our society is undergoing a profound change, which the German Zukunftsinstitut GmbH calls megatrends<sup>1</sup>. What does this have to do with automation and human-machine interfaces (HMIs)? A whole lot ...



Figure 1: Scalable and positionable Widgets show you the right information at the right time.

One example is the megatrend of individualization<sup>2</sup>. Humans want to design their environment more personally and thus identify with it better. This is evident, for example, in the growth of the Do-It-Yourself industry<sup>3</sup>. In e-commerce, mass customization<sup>4</sup> is enjoying increased popularity. What this means is the greatest possible individualization of a product, which is at the same time manufactured industrially and cost-effectively. In extreme cases, this means manufacture in a batch size of 1, which requires the highest possible degree of flexibility in production.

A further megatrend is connectivity<sup>5</sup>, the effects of which we can already feel. It is not just the human who is perfectly networked; smart objects also communicate with one another in private settings as well as in an industrial context. Known as the "Internet of Things" (IoT), the basic requirement for Industry 4.0 has been created. As a consequence, it is not just the speed of production that

increases, tasks of a machine operator are also changing ever more frequently and quickly. A further consequence of the networking is the real flood of information which the user needs to handle. What effects do these developments have on HMIs?

## THE CONTEXT SETS THE TONE

Ergonomics and the best possible support when performing tasks remain central requirements of the user. However, there is also the fact that requirements, the type of information and the amount of information, change ever more quickly. As a result, the context in which a machine is operated also changes. In addition, different users have different requirements. For example, a manager would like to have an overview of the production figures, or the machine operator needs information from the sensors. Another example is a color-blind person who needs higher screen contrasts. A user-defined HMI thus offers the best



Figure 2: Set different skins with one click thanks to Chameleon Technology.

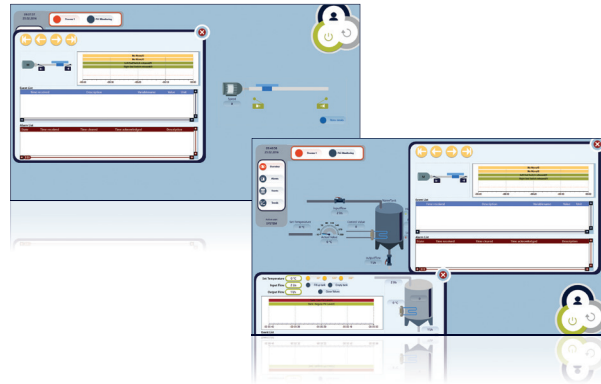

Figure 3: An individually-arranged user interface can be saved as a Runtime profile for each user.

solution to work with the above-mentioned developments. So what would such a user interface on the basis of zenon look like?

Widgets can be created in zenon in order to have a constant overview of currently relevant information. In Runtime, these Widgets can be scaled and positioned with conventional Multi-Touch gestures. Depending on the situation, the user can create their own dashboard this way and easily change this at any time (see Figure 1).

Different user levels allow locking to be set up and control the visibility of elements. This is not just for security, it can also be used for individual user support: a beginner is instructed with more explanations and buttons, while an expert prefers a “short cut” for frequently-used actions, without explanations being shown. Experts also have advanced operating options available, which are not visible for beginners. Different filter profiles such as time filter, AML filter or trend display settings can be created for each user and thus optimally display relevant information according to each task.

## ERGONOMICS CALLS THE SHOTS

In addition to context-based user support, general ergonomic requirements should also be kept in mind, which differ from user to user. A user-defined HMI helps here too:

Different color palettes can be created depending on the time of day, lighting conditions or personal preferences. In the current project, zenon Chameleon Technology allows switching between different skins with one click (see Figure 2). This enables, for example, various color sight deficiencies or the corporate identity of a company to be taken into account.

Screens can be configured with the help of free-form templates and freely positioned using Touch. If they are not required at that moment, they hide at the edges of the monitor. Depending on whether the user is right-handed

or left-handed, windows and dialogs can be arranged as desired, according to the course of the process and the task. The user interface settings can be saved individually with the help of Runtime profiles (see Figure 3).

These were a few examples of how you can optimally cater to the requirements of the user with user-defined HMIs. The user interface amends itself to the user depending on the situation and thus makes the handling of information and quick reactions in processes easier. With zenon, you are best equipped for Industry 4.0 and other future effects of the megatrends – and the proverbial crystal ball becomes unnecessary.

ANITA PERCHERMEIER,  
SCREEN & INTERACTION DESIGNER

## REFERENCES:

[available in German only]

<sup>1</sup> Zukunftsinstitut GmbH.  
<http://kaywa.me/8eVGE>

<sup>2</sup> Zukunftsinstitut GmbH.  
<http://kaywa.me/jirf7>

<sup>3</sup> Handelsverband Heimwerken, Bauen und Garten e.V. DIY-Branchenzahlen.  
<http://kaywa.me/9BfbA>

<sup>4</sup> Piller, Frank T. RWTH Aachen University.  
<http://kaywa.me/Pww0Y>

<sup>5</sup> Zukunftsinstitut GmbH.  
<http://kaywa.me/2UWrM>





# INDUSTRIES

# &

# SOLUTIONS

FOOD & BEVERAGE  
ENERGY & INFRASTRUCTURE  
AUTOMOTIVE  
PHARMACEUTICAL

## A Desire or a Necessity for Improved Productivity?

# GIVE MACHINE OPERATORS A VOICE

In most food & beverage plants, the packaging lines directly affect company business. For example: how seamlessly will the emptied shelves of a shop be filled again with tasty products? A packaging line needs to work perfectly every moment that is demanded of it. This requires high equipment availability, a vital aspect of the overall productivity of a plant. Whether old or new, equipment should be subject to continuous improvement initiatives in which every team member can contribute. This includes machine operators who have an important word to say based on their experience and observations.

Reduced effectiveness results in higher production costs for every single product. Based on line efficiency and downtime analysis, packaging leaders and Total Productive Maintenance (TPM) specialists can observe, measure and act. Typically, a line efficiency system consists of an information flow transforming production data into key performance indicators, such as OEE (Overall Equipment Effectiveness). This means production data is a key success factor. But where does the data come from? And how trustworthy is it?

Today's highly automated equipment offers new opportunities for automating any supporting system, including the plant's line efficiency systems. Data acquired directly from a PLC is quickly available and absolutely accurate. Indeed, international developments such as Weihenstephan Standards or OMAC PackML focus on getting meaningful data from every machine.

### WHY NOT ONLY AUTOMATIC DATA ACQUISITION?

The lifecycle of installed industrial equipment can be lengthy. For older machines, the functionality to automatically acquire meaningful production data may be only partial or may be completely missing. In such situations, combining automatic and manual data acquisition continues to be important for effective line efficiency systems.

When we look at different organizations, machine operators play different roles: from operators fulfilling mainly mechanical tasks to vital, experienced process owners. As long as a production line (still) needs human resources, we must speak about ergonomics at the workplace, competencies and motivation. Software and IT systems offer great examples of how technology networks people with equipment. The human machine interface, for instance, displays process information in real time and assures process control.

This same HMI could also be a place where the operator manually enters his observations as valuable data for later analysis, for example: downtime causes, context information for statistics or free comments on certain events. Here, continuous improvement initiatives, such as TPM, benefit when everyone is an active contributor to plant performance.

### SEVEN TIPS FOR GETTING PRODUCTION DATA FROM MACHINE OPERATORS

The zenon Product Family places an extensive framework of software technologies in the hands of system integrators. They can then transform the production teams' line efficiency system requirements into reality. Let's see how it is possible to profit from zenon when implementing operator-driven data acquisition.

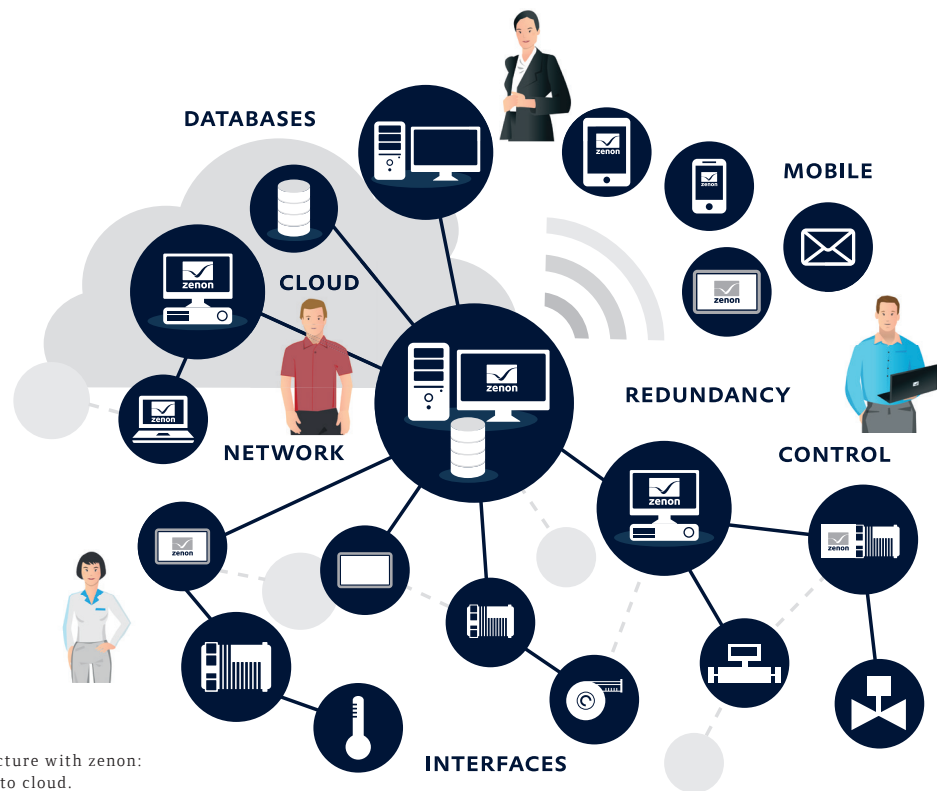

Figure 1: Smart system architecture with zenon: user-oriented and from sensor to cloud.

### 1. WHAT IS THE VISION OF YOUR SOLUTION?

A line efficiency system is a part of a continuous improvement initiative. This means granting a high level of flexibility and scalability to the system itself. The data sources, the flow of calculations and correlations, the integration with other systems, the local or company-wide data archiving, the analytics expressed as real-time indicators or historical reports – any component of the system may be subject to later adaptation in order to deliver additional incremental improvements and may, as such, require further updates. Whether single or multiple integrated applications, zenon's "smart system architecture" (see Figure 1) offers opportunities which can be delivered by the entire product family. A zenon-based solution fits the dynamism of the food & beverage industry: ergonomic, open, secure, flexible and scalable.

### 2. WHAT IS THE PHYSICAL OPERATOR'S INTERFACE?

One possibility is to consider the same HMI as for machine operation, in collaboration with the machine supplier. In plants where one operator takes care of several machines, one solution – which leaves existing equipment unaffected – is to use a supplementary operation panel or PC. Here, zenon offers huge potential with its many-sided support for

client-server architectures and mobile devices. Independent of place, the machine operator can easily deliver information through manual contribution.

### 3. HOW ERGONOMIC IS YOUR USER INTERFACE?

An operator is a busy person doing many different tasks. Therefore, an intuitive interface is vital to make data input simple. zenon's support for the selection of information from predefined tree lists (of downtime causes, for example) enhances data quality. In combination with automatic data acquisition, it offers the proper context for user interaction; for example, assessing downtime for the chosen machine within a given period. Well-structured user options are key for meaningful standardized statistics. However, a free comment typed by the user can also be vital to document a specific event in production.

### 4. HOW CAN YOU SUPPORT DIFFERENT MANUFACTURING ROLES?

In a line efficiency system, there can be many different people dealing with production data, whether during input or later corrections. zenon adapts its interfaces to the logged-in user: what is visible, what can be done, even the complete "look and feel" in terms of design, colors

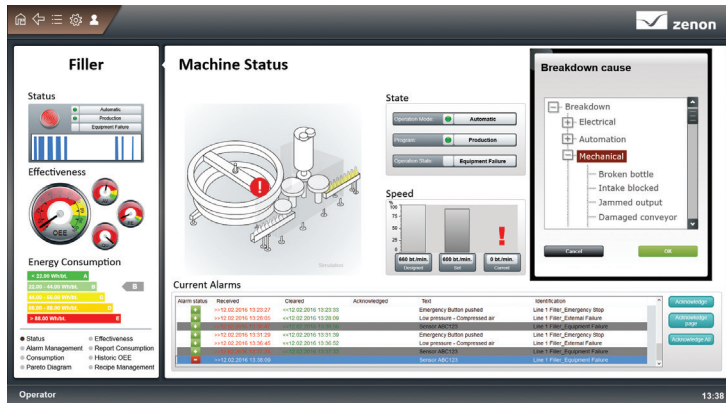

Figure 2: Example of a user interface for the acquisition of downtime causes.

and languages can be adapted. A core technology for this purpose is the user management in zenon. Integration with Microsoft Active Directory avoids duplication of work for automation and IT specialists.

### 5. WHO DOES WHAT AND WHEN?

The quality of the raw data directly affects the way the efficiency system contributes to plant performance. How the human factor influences the statistics' plausibility can be subject of continuous improvement too. zenon makes it possible to document any data input, its time and the user in the chronological event list. This accountability becomes a premise for growing responsibility and competence. The goal is not to make operators fearful of control, but to provide valuable assistance. Such ownership enables operators to identify with the valuable team efforts to move toward key business targets.

### 6. WHEN IS THE DATA AVAILABLE?

Automatic data acquisition delivers a real-time picture of the process. When manually introduced data becomes available depends on the operator. Once it is available, statistical reports can be calculated. One approach is an asynchronous interaction with the system. Without impacting the current process, the operator inputs the appropriate details for every downtime recorded by zenon. Alternatively, zenon's connectivity also makes it possible to link this activity with process events. This means configuring the system so that, after a breakdown, the operator can only restart the machine if he has inputted an observation about the cause. This aids a faster availability of complete production data, for use in analytics and dashboards.

## 7. ENJOY THE LATEST DEVELOPMENTS IN ZENON

Version by version, zenon offers new functionalities as part of its continuous evolution. The newly released zenon 7.50 increases the support for manual data acquisition (see Figure 2): selectable lists of predefined options (e.g. breakdown causes) are now easier to implement. In combination with zenon features, such as alarm management and reporting, the information flow becomes more consistent and reliable.

In successful food & beverage production plants, there is a desire – if not a necessity – to give voice to machine operators. zenon enables a user-oriented approach in the wider context of an integrated plant automation and IT architecture. Our focus is on ergonomics, maximum data quality and high system flexibility.

EMILIAN AXINIA,  
INDUSTRY MANAGER FOOD & BEVERAGE

What is your experience?  
Share your thoughts with us about  
networking people and production  
systems. I'd love further conversation:  
**EmilianA@copadata.com.**



ETHERNET NETWORKS FOR CRITICAL HIGH-SPEED APPLICATIONS:

## SCADA AND PRP – A GOOD MATCH?

TEXT: JÜRGEN RESCH,  
INDUSTRY MANAGER ENERGY & INFRASTRUCTURE

Is a PRP and HSR in Ethernet networks of transformers actually of any use – or does RSTP meet the requirements anyway?

The SCADA component plays an integral part in transformer stations. This was previously the case – and it is now still applicable to IEC 61850-based systems. This is because we monitor and operate the primary equipment systems with SCADA components. Only this way is reasonable local operation of a transformer station possible.

### HIGH AVAILABILITY: A MUST

Local SCADA systems are often designed for high availability, especially at high voltage levels. This is achieved by redundant systems and redundant Ethernet communication interfaces.

The international IEC 62439-3 standard describes two redundancy protocols for Ethernet Layer 2 (in accordance with OSI – Open System Interconnection Model):

- “Parallel Redundancy Protocol” (PRP) and
- “High-availability Seamless Redundancy” (HSR).

These protocols offer “seamless” redundancy with a switching time of 0 milliseconds – a must for critical high-speed applications. But, is this effort really always necessary?

Sure, Ethernet failover times, latency times and speed requirements are important parameters for the different SCADA and automation functions. However, isn’t a cost-effective combination of link aggregation and Rapid

Spanning Tree Protocol (RSTP) sufficient? Most of all for the performance requirements of simple IEC 61850 client/server communication?

### WHITE PAPER PROVIDES DETAILED INFORMATION

However, critical high-speed functions integrated into a SCADA system, such as load shedding using IEC 61850 GOOSE, need the best failover performance. This can only be achieved with PRP and HSR redundancy protocols. Furthermore, the road has already been paved to increased integration of control and protection functions in the central SCADA servers. We will therefore see more and more SCADA systems that are equipped with PRP or HSR in the future.

What matters, and which architecture is the best for your equipment, is described in our new **white paper** “Ethernet Network Redundancy in SCADA and real-time Automation Platforms”.

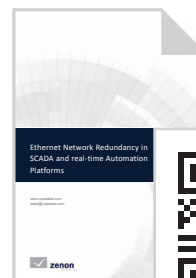

Scan & Download!  
<http://kaywa.me/Y6C72>



DRIVER CONFIGURATION MADE SIMPLE:

# The New zenon IEC 61850 Wizard

**They help make quick progress during everyday engineering and relieve us of inconvenient tasks – the wizards in zenon. They are also an ideal benefit when provided by zenon for IEC 61850-based automation projects.**

In zenon, there are two wizards for working in the world of IEC 61850. One was already introduced in the last issue of *Information Unlimited* (no. 28) – the IEC 61850 SSD import wizard. Now we will take a look at the second – a wizard for IEC 61850 client-driver configuration.

If you configure a SCADA system in order to connect it to an IEC 61850 network, you are taking on a complex task, involving many work stages. This diverts the focus of the project engineer massively to this issue, which is actually not at all desirable. As in reality, the person configuring the project should concentrate on the actual SCADA issues such as screens, reports, data recording and command input. It is necessary to give the project engineer the appropriate freedom and remove any of his concerns about IEC 61850 configurations.

The wizard comes into play here, covering the complete configuration – from creating the driver to importing the variables – in one single user interface. The project engineer thus has a clear overview of everything in one place. The wizard then enters the configuration parameters into the zenon project independently, reliably leading to functional communication in Runtime.

## **WIZARD FOR THE IEC 61850 CLIENT DRIVER**

As usual, this IEC 61850 wizard also starts with a description file in accordance with SCL, i.e. system configuration language in accordance with IEC 61850-6. In an ideal scenario, it is an SCD file, whereby SCD stands for “System Configuration Description”. This is the perfect starting point, because it contains all necessary information and the project engineer hardly needs to make additional inputs. However, we know from practice that this ideal scenario is not always the case. The project engineer does not always have an SCD, for example, if system configuration was neglected. In this case, there are only device description files, such as CID or IID, or even just one ICD file. However, such cases are also covered by the new wizard and here only lead to a little more work towards a functional driver configuration.

What’s really special about the new zenon wizard: it queries the parameters for a functional driver configuration and enters these into the correct position in the zenon project. It independently creates components that are not yet present. It also configures buffered and unbuffered reports. If your SCADA servers have been designed as redundant, the wizard directly assigns the reports accordingly. Lastly, it also creates the required variables in the variable list. The wizard helps you to select the correct variables from the reports and datasets. It therefore also prevents variables that should not be transferred with the report from being used by mistake.

All in all, the project engineer thereby has a unique, linear workflow. Navigation to and from different windows and the old “flying blind” in the sense of “Have I now imported the right variables? Are they also in the dataset of the report in question? And does this report even include this data set?” belong to the past.

With the wizard, the difficulty of driver configuration is reduced considerably and is no longer the main focus. The project engineer can now devote his time to his actual tasks – good usability, clear reports and trends, and intuitive navigation with alarm guidance.

**JÜRGEN RESCH,  
INDUSTRY MANAGER  
ENERGY & INFRASTRUCTURE**

---

Jürgen Resch has been electrified by power stations since his childhood and is always switched on by power lines. You won't need much energy to be won over by his expertise. Find out more at [energy@copadata.com](mailto:energy@copadata.com).



A proud COPA-DATA Energy team (from left to right): Jürgen Resch, Industry Manager Energy, Ursula Kramarczyk, Technical Product Manager and Bernhard Schuiki, Energy Industry Specialist.



# IEC 61850 Edition 2 Certification

AN INTERVIEW WITH ALBI KOSPIRI,  
COMMUNICATION PROTOCOL ENGINEER AND AUDITOR AT TÜV SÜD

In 2015, zenon was certified in accordance with IEC 61850 Edition 2 which means that our software proved its conformity with the most recent additions to the standard. The current test bed for Edition 2 checks new functions of, and additions to, the standard. It is usually the server providing data that is certified to the IEC 61850 standard. zenon acts as a client however, and was one of the first worldwide to be successfully tested with the new Edition 2 of the standard.

The certificate was issued by TÜV SÜD Product Service GmbH in Germany. We were curious and keen to find out more about the process of such an audit and the significance of this certification. So, we thought: Let's ask an expert... and why not the auditor himself?  
No sooner said than done.

## Mr Kospiri, how is an IEC 61850 Edition 2 certification audit carried out?

In order to receive an IEC 61850 certificate of conformity from TÜV SÜD, the customer needs to pass all the required tests within the test plan. The main steps are the following:

- a. Conformance testing: in this step the IEC 61850 Product Specialist reviews the customer's documents and defines the test plan. The evaluation is divided into two main categories:
  1. Static testing: involves documentation inspection and file checking
  2. Dynamic testing: involves protocol testing

If a non-conformity is detected, the customer is notified and a non-conformity report is provided.

- b. Technical review: this stage consists of a complete technical review of the test data and must be made by a second IEC 61850 product specialist. This specialist has to be a different person from the one who has conducted the tests. This is what we call a "four-eye principle" and is mandatory to assure quality. Some of the tests, especially for client application, are carried out manually; therefore a technical double check is a must.



### ABOUT THE AUTHOR:

Mr Albi Kospiri graduated from the Polytechnic University of Milan in 2008. He then worked as a consultant at Siemens Milano as an IEC 61850 system engineer and implemented first IEC 61850 substations in Italy. He has been working as a communication protocol engineer and auditor in TÜV SÜD for three years. Mr Kospiri has in-depth knowledge about IEC 61850 and Smart Grid infrastructures.



### ABOUT TÜV SÜD:

TÜV SÜD is a premium quality, safety, and sustainability solutions provider that specializes in testing, inspection, auditing, certification, training, and knowledge services. Since 1866, the company has remained committed to its founding principle of protecting people, property and the environment from technology-related risks. Headquartered in Munich, Germany, TÜV SÜD is represented in more than 800 locations worldwide. TÜV SÜD operates globally with a team of more than 22,000 multi-disciplinary experts recognized as specialists in their respective fields. By combining impartial expertise with invaluable insights, the company adds tangible value to businesses, consumers and the environment. The aim of TÜV SÜD is to support customers with a comprehensive suite of services worldwide to increase efficiency, reduce costs and manage risk. You can also find more information at [www.tuv-sud.com](http://www.tuv-sud.com).

- c. Technical certification: this is the final stage and is performed by an authorized expert who, on behalf of the Certification Body, will gather all the data (test report, customer data, contracts) and will prepare the certification application. Once the certificate is released by our Certification Body, the Certificate of Conformity, including the certification mark “IEC 61850 Conformity” can be delivered to the customer.
- d. After the certificate has been released by the TÜV SÜD Certification Body and all the customer and product information has been entered into the Certificate Explorer, the technical certifier submits the UCA certificate to UCAIug for approval.

### How strong is the current demand for an IEC 61850 Edition 2 certification audit?

We have been observing a continuous increase in demand of IEC 61850 Edition 2 certificates. Nevertheless, we believe this is a transitional phase a lot of vendors are presently facing. COPA-DATA was one of the first companies to obtain an IEC 61850 Edition 2 certificate for a client application.

### You managed COPA-DATA’s certification audit. As an experienced auditor, what was the most significant thing about the certification of zenon?

COPA-DATA came to our laboratories with clear ideas and the implementation of the Edition 2 of IEC 61850 standard seemed to be carried out by knowledgeable people with hands-on experience of the standard. The testing process didn’t bring up significant issues. The application being tested was a comprehensive SCADA application, which gave us the best chance to examine all the applicable test cases required by the test procedure.

### How happy are you, as auditor, with the development of the certification process with COPA-DATA? Were there particular challenges?

The responsiveness and the understanding of the IEC 61850 from COPA-DATA engineers was notable. Testing an IEC 61850 Client application requires a lot of manual interaction between the test engineer, the test tools and the application. This is definitely a challenge and a potential source of error for a test engineer. In TÜV SÜD, we benefit from a high traceability test bench and the risks to introduce human errors are significantly low. In addition, as explained before, the “four-eye principle” dramatically reduces the risk of errors.

### What can one expect of an IEC 61850 Edition 2 certified software? Why should software manufacturers become certified?

We expect a significant increase of certified products in 2016 and we also anticipate an increase in the number of tenders around the world which will require IEC 61850 Edition 2 certified products as requirements. For this reason, testing and obtaining a certificate for IEC 61850 Edition 2, not only drastically reduces the risk of interoperability issues with other devices and applications in the field, but also enables the vendor to enter in global markets where the certificate is a prerequisite in public tendering.

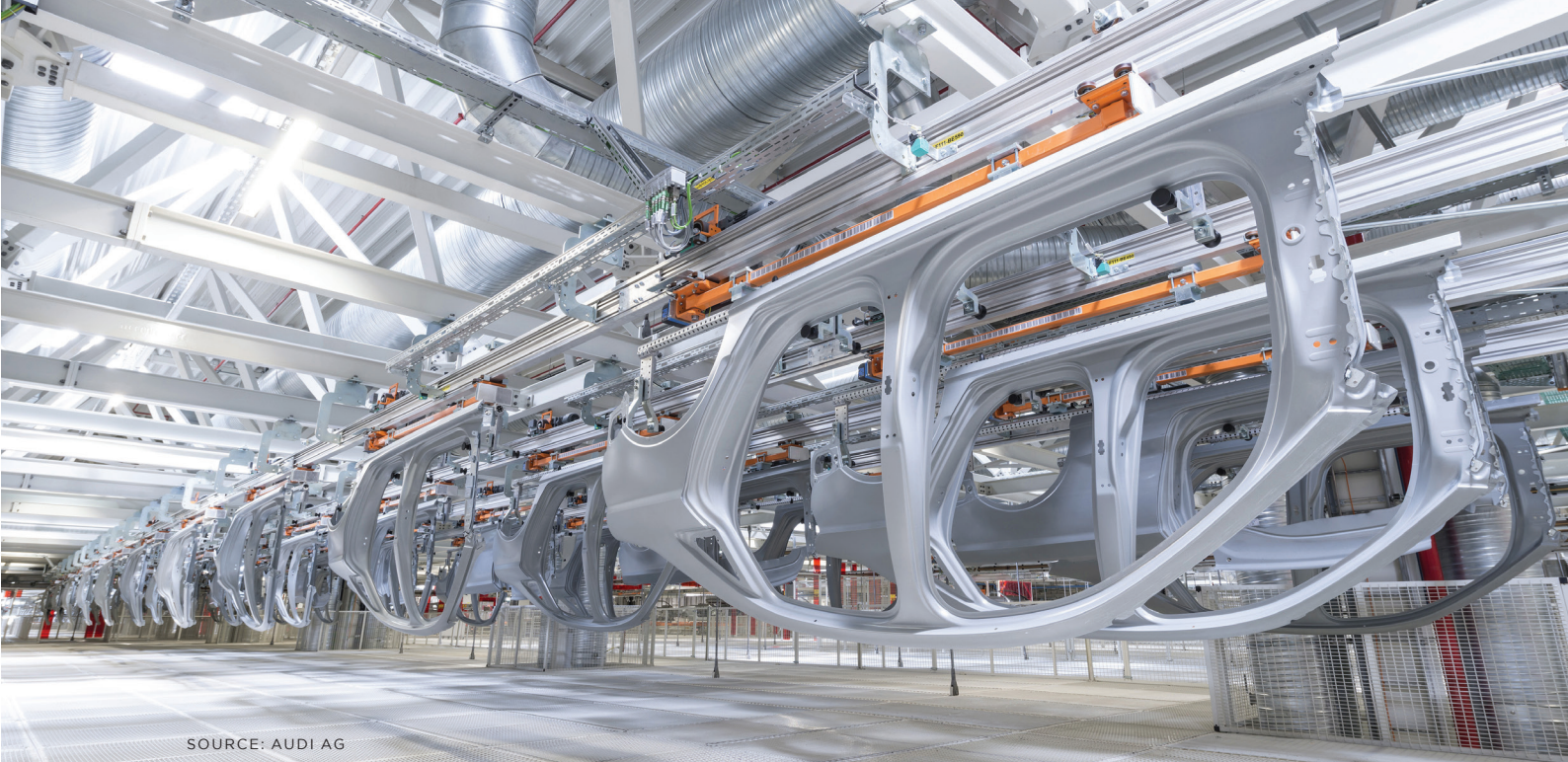

SOURCE: AUDI AG

GENERATE PROJECTS IN ZENON AUTOMATICALLY:

# zag – the Wizard for the Automotive Industry

With the zenon automotive generator (zag), COPA-DATA is offering a wizard for automated analysis of PLC data and the implementation of visualization projects. A major gain for the automotive industry, which traditionally places great value on standardized components and reuse. AUDI AG also relies on our “zag”.

The automation of engineering processes offers considerable savings in time and costs when implementing a project. Tight deadlines can thus be adhered to more easily. The engineer can delegate simple and repeated tasks to the wizard – so more time remains for demanding activities and the risk of incorrect project configuration is kept to a minimum.

## **“ZAG” IN PRACTICE: AUDI AG AS AN EXAMPLE**

In automotive production, vehicle components and bodysells are transported over long routes. At AUDI AG corresponding conveyor belt systems are installed one level

above the actual production level and a maintenance team ensures interruption-free operation.

The individual transport sections are controlled by central STEP 7 PLCs. The control parameters of the transport routes are monitored and managed in the attendant control room. However, manual intervention in the individual transport sections from a central point is not permitted. Only sections that can be examined directly can be controlled manually. The reason for this is primarily the safety of employees. Streamlined Windows CE-based devices can be used because manual operation only requires part of the information from the control room.

## STANDARDIZED ASSIGNMENT OF THE BLOCKS

Corresponding programs have been set up in the PLC for the control of the manual areas that belong to the panels. In doing so, each operable conveyor belt element corresponds to a standard function block in the controller. The assignment of the blocks to the individual conveyor belt elements follows a harmonized, standardized system of call-up parameters. It is also possible to assign conveyor belt elements to several manual areas or overlap these.

When planning the transport layout, the employees in charge define the individual manual areas and the locations of the control panels. When creating the program for central control, the calls of the function blocks are then linked to the appropriate parameters. The layout stipulated by the PLC programmer for the control panels is then taken into account when creating the attendant projects.

## INTERPLAY OF PLC AND VISUALIZATION

The zenon automotive generator reads the required information from the equipment control programs automatically and can set many project properties independently this way. The wizard thus determines, for example, the number and type of projects for the control panels, reads the attendant conveyor system elements and adds them to the attendant equipment screens.

The “zag” also identifies global settings for all projects and configures them in the individual projects. This includes, for example:

- Display of name and status of the different load circuits
- Overview and status of the respective operating types of the control panels

- Setting the network addresses (PLC and control-panel addresses)
- Configuration of the message channel display

The message channel can be used for a detailed display of certain process devices or motor modules. The operator requests detailed data from the controller and it reports that data back for visualization. The type and content of the message channels is provided by the PLC programmer – the “zag” collects the necessary data from the controller program and creates the required operating elements for the user.

## USER-FRIENDLY INTERFACE

With the help of tabs, the user interface of the wizard shows the respective current action of the “zag” with a clear overview. With each further processing step, a switch to the next tab is made automatically. The operator thus receives guidance and a comprehensive overview at the same time. All actions of the wizard are written to a log file for subsequent tracing or analysis.

## CENTRAL DATA STORAGE

The zenon automotive generator stores information from the PLC program in a central file. The actual control-panel projects are generated from the data saved therein. If the PLC program is to be amended at a later point in time, this file is used to make a comparison. Existing projects are only supplemented. In the current version of the wizard, the information is read from a STEP 7 program. The central file allows an expansion of the wizard for other controller types. In this case, only the program part would need to be amended accordingly for data recording and storage. The reading of the central file and the actual project creation can be reused.

---

*“An actual example of zag in use: for the new A4 and A5 product range, we implemented 300 projects with five suppliers for the conveyor systems in the body construction area. A project runs on each control panel. An employee would need five hours per project for configuration without automated engineering. That’s a total of around 1,500 hours. With the zag, only around five hours plus subsequent visual corrections of around another five hours were necessary.”*

**ERWIN-SEBASTIAN MEILINGER**, AUTOMATION SYSTEMS PLANNER, FOR AUTOMATION SYSTEMS IN THE PAINT SHOP AND CONVEYOR SYSTEMS AREAS AT AUDI AG

---

*“The zenon automotive generator from COPA-DATA provides clear advantages. First, we save a considerable amount of time and therefore costs when configuring new equipment. Second, with the zag, we can guarantee that all projects are harmonized and free of errors. For example, no unnecessary variables are created, projects are streamlined and accurate. All in all, with the zag we were able to increase the quality of equipment configuration and increase productivity.”*

**ERWIN-SEBASTIAN MEILINGER**, AUTOMATION SYSTEMS PLANNER, FOR AUTOMATION SYSTEMS IN THE PAINT SHOP AND CONVEYOR SYSTEMS AREAS AT AUDI AG

### SIMPLE WORK WITH THE “ZAG”

Once the “zag” has been started, the user configures the wizard. In doing so, he stipulates the name of the central file and selects the attendant STEP 7 program using a combobox. Once all required data has been read from the PLC program, it is saved in the file and displayed in groups with a clear overview using the “zag”.

In this summary, all control-panel configurations stored in the PLC code are also visible and ready for project configuration. The wizard operator can now select which control-panel projects he wants to create. The wizard carries out the following steps when creating a project:

1. Entering of the global data into the template project, including for example the IP address of the controller, configuration of the load voltages and operating modes
2. Copying the template project and automatically applying it to all control-panel projects
3. Activating control-panel-specific variables and addressing them correctly
4. Adding conveyor system elements assigned to the respective control panel from the symbol library, into the operating screens and linking them to the corresponding variables
5. Adding and configuring load circuit and mode symbols necessary for manual operation
6. Configuring the message channel diagnosis screen
7. Setting control-panel address for Remote Transport and create zenon Runtime files
8. Done! The control-panel project is now ready to transfer data to the panel.

The “zag” now automatically creates the manual operation screen, on the basis of the information read from the PLC program, and adds the attendant conveyor system elements into the operating screens of the control-panel projects. The person configuring the project can then move these elements to the correct position and also rotate them.

A tailor-made conveyor system layout is thus created if desired. It is of course also possible to subsequently amend or supplement projects with further conveyor system components, by means of an update function in the wizard.

Some of our renowned customers in the automotive sector are already using the zenon automotive generator. It has now been operating successfully at AUDI AG for three years.

**BERND WIMMER**,  
INDUSTRY MANAGER AUTOMOTIVE

**Video:**  
**Save up to 98% of engineering time with the “zag”**  
Scan & Play!



The video player thumbnail features the COPADATA logo in the top left corner. The main text reads 'zenon automotive generator' and 'save up to 98% in engineering time'. Below the text, there is a large play button icon. In the bottom right corner of the video player, there is a QR code. The email address 'automotive@copadata.' is visible in the bottom right corner of the video player area.

<http://kaywa.me/d5mcp>

## IoT Impact on Pharma Manufacturing

# CONNECTIVITY IS THE NEW SMART!

TEXT: ROBERT HARRISON,  
INDUSTRY MANAGER PHARMACEUTICAL

The terms “Industry 4.0”, “Smart Factory” and “Industrial Internet” are the sounds of the “Internet of Things” (IoT) reaching the shores of industrial manufacturing – and they are poised to make radical changes to pharmaceutical production operations. With strong talk of increased productivity and energy efficiency as well as massive reductions in production costs and downtime, one cannot help but tune in to the future knocking at the door.

Imagine a world in which things can communicate with other things, collecting and exchanging data. Objects are sensed and controlled remotely across existing networks. This is a world in which things are conjoined with their users across the company and its partners, no matter where they are. At the heart of this world is the complete integration of people, processes and data.

Intelligent sensors, networks, storage and cloud services – these are the essential elements that make the IoT possible and they are becoming easily accessible and affordable to an increasing number of companies. This means that the factories of the near future could have every device connected to one network and analyzed for many purposes. It is hoped that this will lead to intense production cost savings through energy reduction, waste reduction, impeccable quality and increased productivity.

It is clear that running manufacturing efficiently is moving into a new era. Plant operations are being challenged with the question: what do you plan to do differently going forward?

### **FACILITIES OF THE FUTURE**

The scope of the IoT is phenomenal. Measures are being integrated into existing technologies with a promise of near-limitless improvement to our everyday lives. In the mainstream you can see anything from internet-connected home refrigerators to citywide Smart Energy grids. Pharmaceutical manufacturers are asking two questions: 1. How can the IoT be beneficial for my business? And 2. How do I implement it?

### **BENEFITS**

So how will economic impact be generated? How do you achieve energy efficiency and/or process efficiency? How do we reduce waste and increase productivity? Is it a black box you can plug into a plant and then walk away from to witness the benefits? Of course, life is just not that simple ...

Such mechanisms require company strategy, cultural changes, and change management. Industrial IoT can provide you with data; information to visualize in such resolution you really see your processes in motion. But first

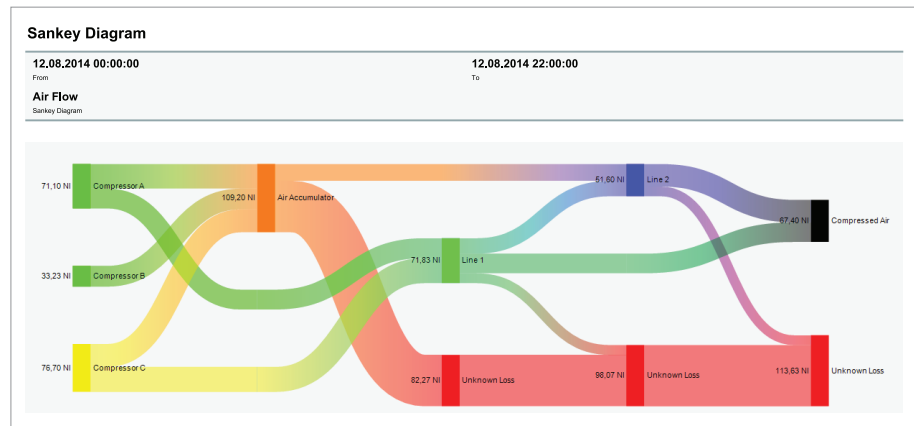

Figure 1: zenon Sankey diagrams visualize energy flows. Here, it displays compressed air usage: from air compressor outputs, through flow rates in circulation, to consumers and a review of losses.

it requires a clear understanding of strategy and processes. The data it can provide can be abstracted to focus on specific usages and areas.

**PROCESS OPTIMIZATION:** The potential of the IoT comes from the ability to monitor all aspects of the process with much greater resolution and accuracy, also across the boundaries of industrial automation systems. All process values could be accessed at every stage, including temperature, pressure, weight, flow, pH, dissolved oxygen, humidity. The IoT makes it possible to visualize the process, understand the science and see where the edge of failure lies. Parameterize the process and monitor with increased resolution to create a control strategy and alerting mechanism that prevents the equipment from ever reaching or getting close to your predetermined limits.

When we talk about process, we are referring to every small process loop or discrete control in the plant. This is a science: to advance with an accurate vision. And it is in this vision that you can find the paradigm shift for improvement.

**ENERGY USAGE:** In a facility with a network of connected devices, you can see accurately how much energy is being used, and what is consuming it. Then execute the same strategy for optimization as you did with your process improvements. The first step is to understand your facility, understand “why”. Then the IoT makes it possible to more easily and accurately calculate efficiency for each piece of hardware, process, or line. Energy Managers are then

empowered to make the choice to optimize use; continuous improvement is then easily rewarded and clearly seen.

The IoT is already growing the idea of improved visibility far beyond current understanding. Allowing equipment remote access reduces production costs through intelligent supervision. Connected manufacturing environments promote reliability and sustainable operations; improving decision-making all the way up the ladder to business optimization.

## IMPLEMENTATION

Industrial IoT is far more advanced than commercial IoT, mainly due to the high prevalence of sensors in the industrial world. The mechanisms to integrate new or additional devices into industrial systems is well understood, particularly in zenon-based systems because of the wide scope of communication drivers available in zenon.

Sensors and devices are the “Things” in the IoT. Connectivity is therefore a key factor and, more particularly, the flexibility of connectivity. This is a continuously evolving platform: bridging existing processes and new process sensors. Interoperability translates data from disparate sources, from one layer to another, passing information intelligently and bi-directionally. When this is combined with seamless integrated access to information from the shop-floor to higher management – and further business partners such as CMOs – the possibilities for improvement are maximized.

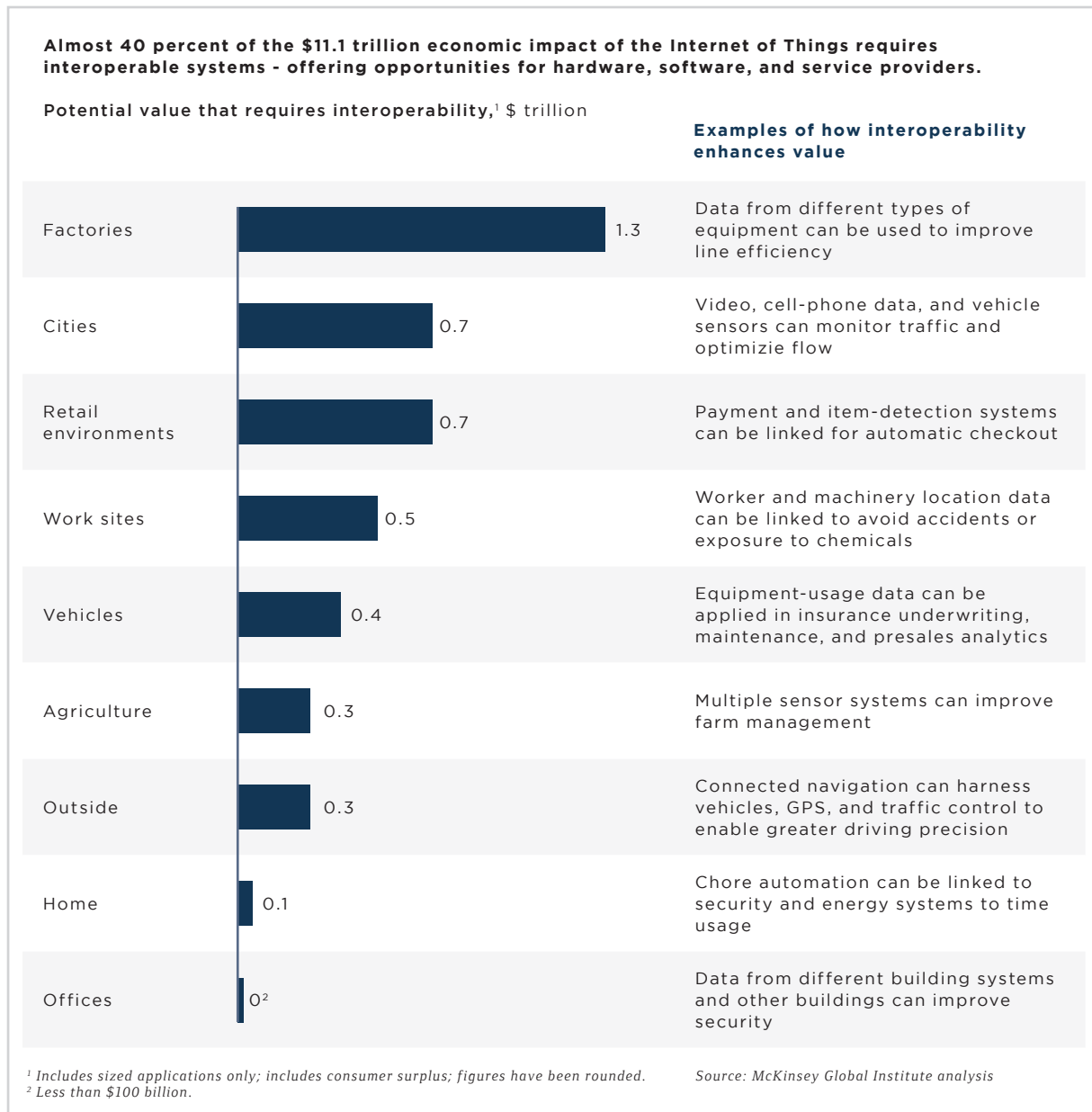

Figure 2: McKinsey's view on the global impact of IoT credits factories with the most to gain financially.

Continuous improvement by its very nature means you don't know what you will do at the next turn. This makes it vital that flexible connectivity should be easy to achieve, allowing new devices to be added, using different protocols optimized for the chosen device. Process and business applications often demand modularity and this is a further driver for flexibility. Making it simple to plug in and plug out mechanisms without impacting production or business is key.

Analytics and visualization empower you to bring meaning to the massive raw input of the IoT. Real-time data enters the system and can be filtered and stored using data historian tools. Real-time data can then deliver more than real-time visibility: it offers predictive analytics. Through your system, you can foresee critical events and maintenance well in advance, and ensure compliance and improved quality.

## CONNECT AND BRING DATA TO LIFE

zenon already delivers this much-desired functionality to support IoT initiatives.

**Connect** with data sources. zenon enables you to bring existing infrastructure and new technology onto the same page. Using zenon, you can create data networks across multiple layers from physical sensors up to the cloud; offering access to production, operations, planning, and business strategy. zenon supports the integration of data from varying sources under the watchful eye of regulation compliance, for example the FDA Part 11 with its demands of data integrity, consistency, security and authorization.

**Historical and real-time information** puts emphasis on efficient data storage. As increasing amounts of data are collected, storing data at the right time and frequency becomes more important. zenon enables you to store data intelligently where you need it, to aggregate data, and capture process understanding.

**Visualization.** The value of data is brought to life through analysis, taking raw data and turning it into actionable information. zenon's visualization dashboards and reporting solutions convert remote machine monitoring into performance metrics. Measurable markers such as energy KPIs or OEE can be easily defined. Predictive algorithms learn your processes, identify potential problems, and communicate the status of a facility in real-time.

Changes to the way we work mean visualization must be available everywhere, whether you are on-site at a PC, or mobile with a smart phone, tablet, email, or SMS. zenon supports this way of working and through complete automation a better allocation of resources is possible.

**Planning.** Clarity and visibility across the value chain generate business insights. Because zenon gives you your current facility status at hand with visual feedback, it provides gravity to leadership teams.

**Improved quality and compliance.** Smart systems with greater precision and visibility offer better control with real-time reporting. This will eventually eliminate manual data retrieval and analysis. Automated data acquisition improves regulatory reporting. A better understanding of the manufacturing process facilitates better decision-making, where critical exceptions can be handled swiftly. zenon supports manufacturers to ensure productivity and efficiency originates from an improved quality environment of "right first time" and which results in less waste.

Internet of Things is a highly dynamic, future-ready technology. It has to be highly scalable and flexible, allowing newer applications to evolve and support new devices. zenon lifts processes out of the physical layer – start thinking about Moore's law – so you can move intelligence up the ladder to more capable systems.

## STRATEGIC GROWTH TOOL

The pharmaceutical manufacturing facilities of the future will go well beyond current standard methods of operations and development. The IoT will add orders of magnitude to QbD (Quality by Design), with six sigma performance made possible on all quality parameters.

The IoT vision is one of highly automated production with high levels of visibility in all processes. Equipment will be highly precise, process controls will be well understood and constantly refined. As a result, in the IoT-driven plant, products remain cost-effective long after patent expiry.

**The Internet of Things has arrived: you simply need to ask for it!**





AROUND  
THE  
WORLD

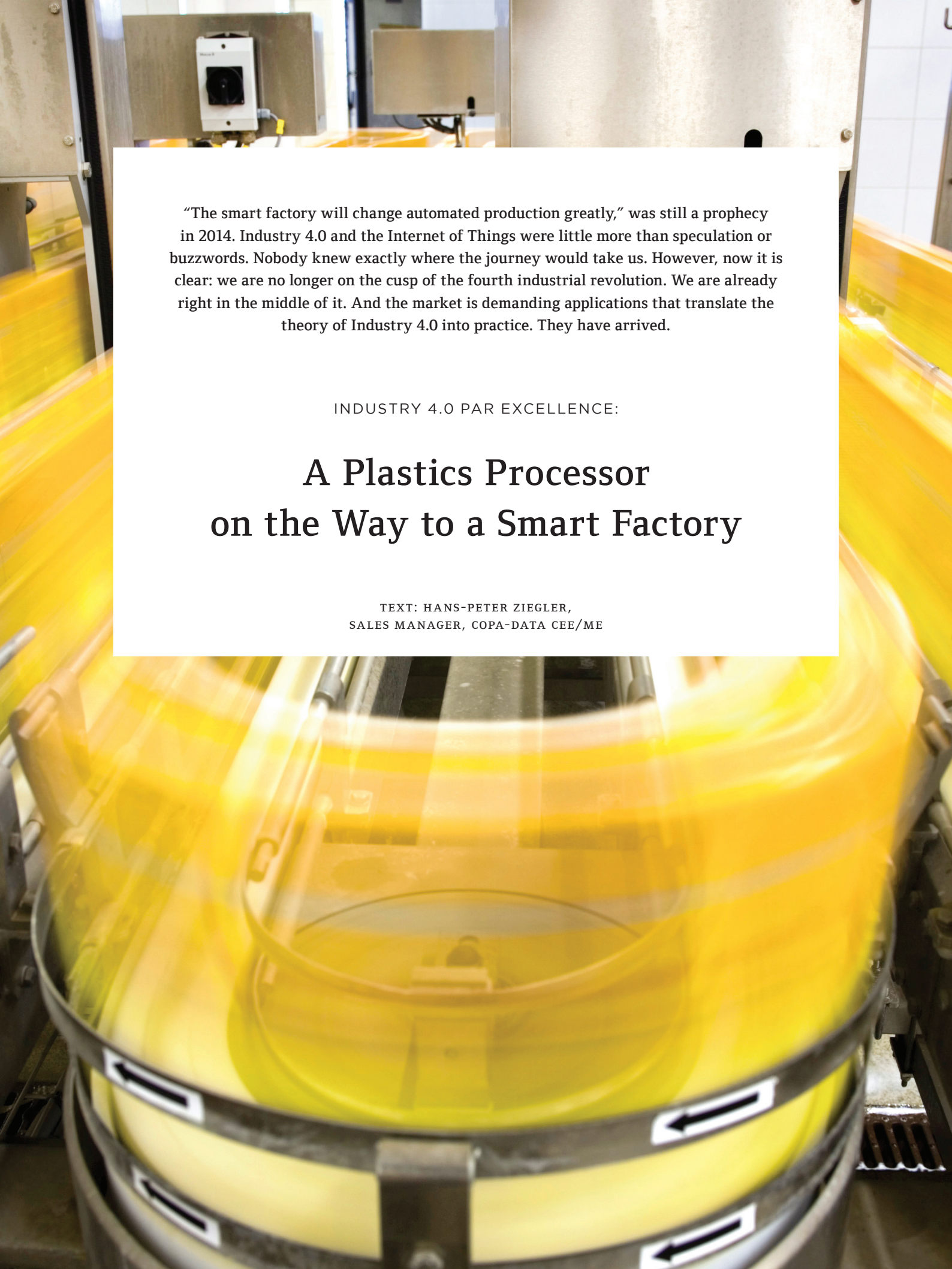

“The smart factory will change automated production greatly,” was still a prophecy in 2014. Industry 4.0 and the Internet of Things were little more than speculation or buzzwords. Nobody knew exactly where the journey would take us. However, now it is clear: we are no longer on the cusp of the fourth industrial revolution. We are already right in the middle of it. And the market is demanding applications that translate the theory of Industry 4.0 into practice. They have arrived.

INDUSTRY 4.0 PAR EXCELLENCE:

## A Plastics Processor on the Way to a Smart Factory

TEXT: HANS-PETER ZIEGLER,  
SALES MANAGER, COPA-DATA CEE/ME

The intensive discussion about the fourth industrial revolution has already reached open-minded users and led to a corresponding raising of awareness. An international plastics processor headquartered in Austria has reacted to these new ideas. They came up with a plan to structure their new lines for the manufacture of plastic packaging in such a way that it met the demands of Industry 4.0 in full. For this, competent partners with technologies that cooperate optimally were necessary.

The optimization of production in the smart factory is clearly a team task. In order to equip production plants with full Industry 4.0 functionality, in addition to innovative automation solutions, effective IT partners are essential. Together with Kapsch BusinessCom as the general contractor, COPA-DATA has managed in a real manufacturing environment to combine information and communication technology (ICT) and the control level into one complete solution.

into the equipment and cause a concerted reaction from the actuators in all parts of the equipment.

A sufficient Big Data analytics platform allows the creation of forecasting models in addition to information about the status of equipment. Analytics use cases can be implemented with the saved data, which can help, for example, to minimize waste or to carry out preventative maintenance in good time.

### **PRODUCTION OPTIMIZATION AS A TEAM TASK**

Kapsch BusinessCom AG specializes in the design, implementation and integration of information and communication technology with security and backup systems. With over 1,400 employees and just under 300 million euros of annual revenue, the Viennese company is a leading ICT service provider in Austria and Central and Eastern Europe. Kapsch BusinessCom has started to

---

*“As the international leader for automation software that is made in Austria, COPA-DATA is a very important partner for us. With their expertise, COPA-DATA perfectly supplements our ICT competence in Industry 4.0.”*

**PETER WÖHRER, MANAGER OF BUSINESS SERVICES SOLUTION UNIT AT KAPSCHE BUSINESSCOM**

---

### **LOOK INTO THE FUTURE WITH BIG DATA**

The ambitious vision of the manufacturer: adaptive production that is easy to monitor and control from management board level and also reacts flexibly to changes in order details, primary material properties and environmental conditions. This primarily needs valid data for a realistic outlook on the future. The requirements for this are high.

For energy-efficient and result-optimized large-scale mass production of highly individualized products, it is necessary to combine all data from the complete production level in real time and to process it at a higher, semantic level. To do this, the sensors and controllers of all parts of the equipment must have their data closely meshed with one another. This also includes all transport equipment, handling devices and auxiliary units, as well as building services. The data created there must be checked, prepared and, depending on further use, stored in a harmonized or multi-modal form.

An extract of this information aids company management in the monitoring and control of equipment. Amended set value requirements for the process must – once prepared for each individual machine – flow back

develop strategies for the logical extension of the services it offers into the production line. In doing so, it wants to support Austrian companies to achieve the next stage of smart production.

“With such tasks, the central challenges are the combination of different interfaces, protocol types, and data formats,” says Peter Wöhrer, Manager of the Business Services Solution Unit at Kapsch BusinessCom. “Data reliability and security are decisive for production stability and the resultant product quality.”

### **LINE AUTOMATION WITH ZENON**

The zenon Product Family is ideal for this task and can cover large parts of it out of the box. zenon works independent of the controllers and protocols used and collates and saves all data from this heterogeneous environment. The congenial reporting components create reports for the management level. The return notification of the process adaptation back to machine level is also carried out using zenon.

Dashboards as front end make it possible to monitor and control the entire equipment very easily. Operators are not overwhelmed by the enormous complexity of the equipment. They are free to make decisions on the basis of strategic considerations.

The ICT Austria platform (ICT stands for Information and Communication Technology) was decisive for the close cooperation between Kapsch BusinessCom and COPA-DATA. It works on the networking and cooperation of experts from different areas to strengthen the complete ICT value-added chain in Austria. COPA DATA has been a member of ICT Austria since 2015.



## ABOUT ICT AUSTRIA

ICT Austria was founded in 2014 with the objective of strengthening ICT added-value in the country and offering the highest standards for data security. Nationally and internationally-active Austrian IT companies bundle their competence throughout the complete value-added chain, in order to develop ICT offers and services for customers in Austria and around the world and to strengthen the significance of ICT for the area's economy. ICT Austria is considered the "missing link" between the ICT solutions of international providers and the users.



**WOLFGANG HORAK,**  
Director, ICT Austria

"With its zenon software already installed at companies in more than 70 countries, COPA-DATA is an excellent addition to the network of Austrian IT initiatives."

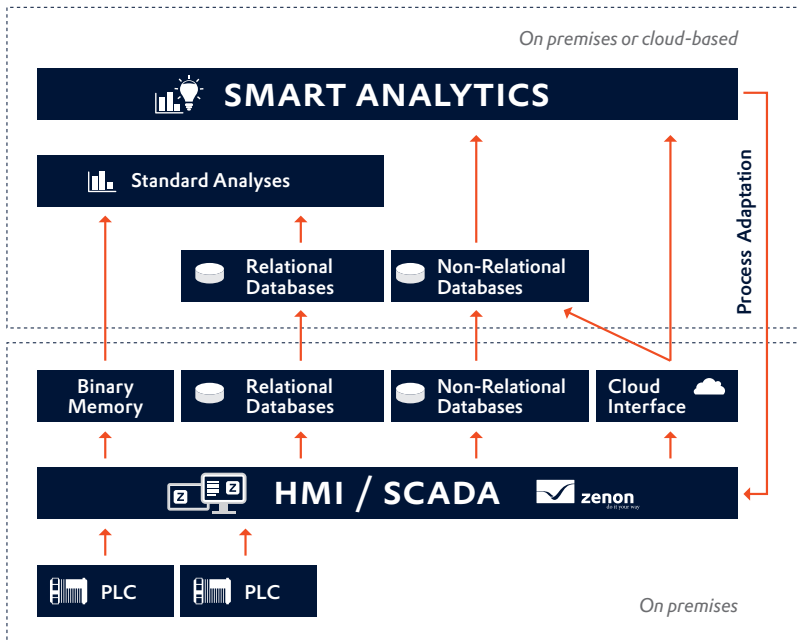

## IMPLEMENTATION STEP-BY-STEP

The plastics production lines are not yet in operation with the planned far-reaching implementation of the basic thinking behind Industry 4.0. However, the interaction of the field and machine level with zenon has already been extensively tested, as has the monitoring of the equipment using the management dashboard. The next step is the conversion of the database technology and then the implementation of real-time data analyses in the Kapsch systems.

The process optimizations that arise from these analyses will then support resource-saving and energy-efficient, adaptive operation of the production lines. For the first time in Austria, a production facility will apply the future-orientated methods of Industry 4.0 by using interlaced technologies. Its success will be very easy to measure because other equipment absolutely identical at machine level will be available for comparison.

## THE FUTURE OF PRODUCTION HAS STARTED

Based on the technologies of the project partner, a system kit has been created as part of this project which makes it relatively easy to give production equipment full Industry 4.0 functionality. An Austrian solution for the complete computerization of production lines and companies has thus been created.

Further information about the project partners:  
[www.kapschbusiness.com](http://www.kapschbusiness.com)  
[www.ictaustria.com](http://www.ictaustria.com)

# Bienvenue COPA-DATA France!

Since its founding in 2002 COPA-DATA has held the majority stake in COPALP. With its renaming to COPA-DATA France our French subsidiary is now officially part of the global COPA-DATA Group and, in addition to its embedded software business, will take over the management of local sales of zenon.

The embedded platform straton will continue to be developed and marketed by our French colleagues. It offers an integrated development environment with which PLCs can be tailored as needed. The best part: the networking of straton and zenon enables mechanical sensor data to be rapidly and reliably transferred to higher-level systems as well. This results in many powerful application possibilities in the areas of HMI/SCADA, Reporting, IoT and Cloud.

Et voila, curtain up for our team at COPA-DATA France



**Jérôme Follut (8)** is CEO of our French subsidiary: “We are excited to represent zenon in association with straton on the French market.”

As an “adventurer”, Jérôme seeks his thrills by parachute or through his latest project: ice diving.

**Sébastien Roberto (1)**, Sales Manager: A “pilot” who is soon likely to be flying by helicopter to his many business trips.

**Christian Jargot (2)**, Customer Support: A passionate jazz guitarist, alias “Jazz man”.

**Philippe Carlier (3)**, Customer Support: This “joker” gets a kick out of complicated jokes and enjoys ski tours.

**Daniel Digonnet (4)**, Software Engineer: The wise “Grandpa” of the team who always has great advice at hand.

**Michael Gerlin (5)**, zenon Customer Support: As a “marathon man” he loves climbing and runs and runs and runs.

**Philippe Breyse (6)**, Software Engineer: “Mr. Grumpy”. Even though his favorite word is “Non!”, he always means well.

**Anthony Burille (7)**, Software Engineer: The “gadget geek” of the team who has always bought “the next big thing” months ago.

**Elsa Magalhaes (9)**, Marketing Manager: A “shoe addict”. We presume she owns a large number of shares in the global footwear industry.

**Laura Leplus (10)**, Office Assistant: Despite her harmless appearance, the “youngster” of the team can transform into the Hulk at any time.

**Anthony Ralay (11)**, Software Engineer: A “roller skater” who is happiest skating around and organizing skating events.

---

## COPA-DATA France

Parc Sud galaxie, Rue du Sextant  
38130 Échirolles | France

Tel.: +33 (0)438 2600 75

Fax.: +33 (0)476 2634 17

sales.fr@copadata.com

## WHO IS WHO



### Anton Wiesner

JUNIOR SALES ENGINEER

COPA-DATA GERMANY

**AT COPA-DATA SINCE:** 2015

**RESPONSIBILITIES:**

I'm the regional contact for all sales activities for the eastern fringes of Germany, from the Alps to the Baltic Sea. With the entire COPA-DATA team, I'm paving the way to long-standing, successful business relationships with potential and existing customers. Our team develops various solutions cross-industry – that means a new challenge awaits every day! This diversity and getting to know many new people are my personal "fun factors".

**I GET MY INSPIRATION FROM ...**

hikes in local mountains and various other sports. Furthermore, I find activities with my family and friends a great balance to work life.

**IF I COULD DO AS I WANTED, I**

**WOULD ...** build my own race track and spend my free time watching motor races with friends.

---

You can reach me at:  
anton.wiesner@copadata.de



### Stefan Hufnagl

PRODUCT MANAGER INTEGRATED SOLUTION

COPA-DATA HEADQUARTERS

**AT COPA-DATA SINCE:** 2013

**RESPONSIBILITIES:**

As a Product Manager I accompany the evolution of our software. In particular, I coordinate the development within the zenon Logic sphere. I'm thereby in permanent interaction with zenon users and developers. The further development of zenon Logic takes place in close collaboration with the COPA-DATA France team, the competence center for embedded technologies for COPA-DATA. I coordinate requirements, concepts and application designs with colleagues from sales and technology as well as with COPA-DATA partners and customers. On a strategic level, I deal with all relevant industry standards, trends and application initiatives such as the use of zenon in the process industry.

**I GET MY INSPIRATION FROM ...**

the time I spend with my family, listening to music from different genres – ranging from industrial metal right up to classical music – as well as from opposites and contrasts.

**IF I COULD DO AS I WANTED, I**

**WOULD ...** take my time to learn a lot of new languages.

---

You can reach me at:  
stefan.hufnagl@copadata.com



### Gareth Hogan

TECHNICAL CONSULTANT

COPA-DATA UK

**AT COPA-DATA SINCE:** 2014

**RESPONSIBILITIES:**

I'm responsible for supporting customers with technical queries in the UK and Ireland, providing training in the use of zenon and assisting with presales for the UK sales team.

**I GET MY INSPIRATION FROM ...**

music, sports, my family and friends. I am also inspired by both pre-meditated and random acts of kindness. From tipping a friendly waiter to putting a funny post-it note on a colleague's desk – even the smallest gesture can brighten someone's day.

**IF I COULD DO AS I WANTED, I**

**WOULD ...** travel the planet discovering the history and culture of each country. I find other countries' perceptions of the world fascinating and I'm also sure there would be a lot of beer to sample along the way (essentially making it the world's longest pub crawl).

---

You can reach me at:  
gareth.hogan@copadata.co.uk

## WHO IS WHO



### Diego Fila

SALES ENGINEER

COPA-DATA ITALY



### Mark Clemens

TECHNICAL PRODUCT MANAGER

COPA-DATA HEADQUARTERS



### SungHo Ryu

MANAGING DIRECTOR

COPA-DATA KOREA

**AT COPA-DATA SINCE:** 2014

**RESPONSIBILITIES:**

My role at COPA-DATA is to deal with activities relating to sales in North-Eastern Italy. I work closely with my sales colleague Giuseppe Menin, whose experience and expertise give me the same enthusiasm he puts into his work. My workdays are very interesting and exciting, consisting of activities such as preparation and follow-up of customer visits, sales presentations of zenon, and maintaining and establishing new relationships with customers. Travelling to visit potential clients is an important task that gives me the possibility to see a wide range of different industries and manufacturing plants.

**I GET MY INSPIRATION FROM ...**

almost everything around me: events, relationships with different people, books, music, movies, travel and mountain landscapes.

**IF I COULD DO AS I WANTED, I**

**WOULD ...** live my dream, actually more than one.

---

You can reach me at:  
diego.fila@copadata.it

**AT COPA-DATA SINCE:** 2002

**RESPONSIBILITIES:**

As a technical product manager and senior consultant, my main focus is on the following areas: DNP3, OPC classic and OPC UA, Recipegroup Manager, zenon network, Weihenstephan standards, and last but not least, cyber security. Apart from that, I support colleagues with troubleshooting of all other zenon and non-zenon related technical issues reported by zenon users.

**I GET MY INSPIRATION FROM ...**

seeing continuous improvements in all aspects of things that you put efforts in to eventually reaching heights not yet imagined.

**IF I COULD DO AS I WANTED,**

**I WOULD ...** visit farms in remote mountainous regions where they grow Coffea arabica, to source the best green beans and master the artisan craft of roasting coffee beans for producing specialty coffees in my own café.

---

You can reach me at:  
markc@copadata.com

**AT COPA-DATA SINCE:** 2013

**RESPONSIBILITIES:**

I'm responsible for both sales and technical support management for the Korean market. My vision is to expand the reach of COPA-DATA throughout Korea and the Asia region through targeted marketing and excellent products and support. I also work hard to help every member of the COPA-DATA Korea team realize their potential and to support and develop their work and abilities.

**I GET MY INSPIRATION FROM ...**

the highly respected Korean naval hero Admiral Yi Sun-sin. With preparation, trusted intelligence and careful planning, Admiral Yi repeatedly overcame seemingly unsurmountable odds to achieve victory.

**IF I COULD DO AS I WANTED, I**

**WOULD ...** travel all around the world, enjoying the beautiful scenery and cultural differences. I'd also like to meet and make friends with the diverse range of people from around the world that I would meet on my travels.

---

You can reach me at:  
SungHo.Ryu@copadata.com

ZENON POWERED BY ...

# Get to know our Distributors

Under the title *zenon powered by...*, we are inviting our distributors to the stage. In this issue our new distributors from Vietnam and Brazil are introducing themselves.

## PETROLEC - PETRO ELECTRIC ENERGY

Your zenon Sales Representative in Vietnam



Thomas Punzenberger and Thanh Pham Ngoc, Chairman of the Management Board at PETROLEC, are now joining forces to market zenon in Vietnam.

In 2012, Petro-Electric Energy Joint Stock Company (PETROLEC) was founded in Vietnam. Our ten specialized and highly experienced employees attend to the needs of our customers who come in large part from the energy sector. Our director, Giang Nguyen Binh, is an automation engineer with in-depth knowledge of protection relays and secondary diagrams in high voltage substations and hydro power plants, SCADA systems and telecommunication systems.

Before finding zenon, PETROLEC concentrated solely on offering commissioning services for substation automation systems for Siemens Vietnam and GE Vietnam. In the last year, having assessed zenon for ourselves, we have been convinced that zenon Energy Edition is the most flexible and reliable product on the market. This year, our team will start promoting zenon as the best software solution for substation automation and control center systems throughout Vietnam and Southeast Asia.

## PETROLEC - PETRO ELECTRIC ENERGY JSC

No. 10, Tran Nguyen Han street,  
Hoan Kiem district, Hanoi, Vietnam  
Tel: +84 4 3266 8801  
info@petrolec.vn  
www.petrolec.vn

## SOLUTION SISTEMAS

Your zenon Sales Representative in Brazil



Ricardo Nicolini receives the certificate as Distributor in Brazil from Thomas Punzenberger.

Since 1999, SOLUTION SISTEMAS has specialized in providing software services and products to a variety of industries including mining and metals, cement, power generation, automotive, and food & beverage. Our company portfolio includes instrumentation, electrical and automation design, DCS, PLC, SCADA and HMI software development, plant optimization, device network troubleshooting, report management, PIMS and MES applications, training and plant commissioning.

As a team, SOLUTION SISTEMAS' technicians help define requirements, parameters and strategies and create approaches to fulfill customer demand. We decided to work with COPA-DATA because we believe that zenon is the most innovative and cost-effective integrated automation solution on the market.

Our CEO, Ricardo Nicolini, should be your first point of contact for any business and commercial issues. Technical questions and general customer service are covered by our team of technicians.

## SOLUTION SISTEMAS

Avenida Professor Mário Werneck, 26, sala 702  
Belo Horizonte, MG, CEP 30455-610, Brazil  
Tel: +55 31 3335 5169  
ricardo.nicolini@solutionsistemasbr.com  
www.solutionsistemasbr.com

# Growing Together at the COPA-DATA Global Partner Academy

On June 15-16, the COPA-DATA Global Partner Academy (GPA) is taking place in Munich, Germany. This is the opportunity for our partners to gain insights into the latest zenon developments and meet COPA-DATA experts face-to-face.

## A WIN-WIN-WIN AT GPA 2016

At GPA, our partners receive straightforward and detailed information about zenon and also engage in networking and discussions. The event is a great opportunity to get direct feedback from our partners, thereby aiding the further improvement of the zenon Product Family. GPA is a true win-win-win for all: partners, end customers and COPA-DATA. Together we ensure that zenon continues to evolve, giving more people the possibility of enjoying ergonomic automation at their workplace.

## AN AGENDA FOR ALL NEEDS

With different tracks and focuses, the GPA agenda covers the different needs of our partners. Two main topics for this year are "zenon for Smart Factories" and "Substation Automation – HMI Fast & Furious". There will be several parallel tracks, to ensure that all participants can cover their knowledge needs – from in-depth expert tracks to interactive information on new features.

In the Smart Factory track, our partners will be able to gain insights into how to build Smart Factory applications from scratch, use automated engineering and integrate mobile apps, predictive analytics, cloud technology and big data.

In the substation automation track, we will deliver further insights into automated engineering, IEC 61850 Edition 2, Command Sequencer and a lot of helpful tips and tricks that will fundamentally enhance our partners' zenon know-how.

"I look forward to having a dedicated Energy Track during this year's GPA," says Jürgen Resch, Industry Manager Energy & Infrastructure at COPA-DATA. "There are many new possibilities in zenon 7.50 Energy Edition, for example with IEC 61850, and I can't wait to share more in-depth knowledge and future insights with our partners. Together we can deliver an even stronger solution for our end customers."

## GET ANSWERS FAST AT A FACE-TO-FACE MEETING

A much appreciated opportunity at GPA is the chance to book face-to-face meetings with our zenon experts in which specific topics can be discussed. They offer the possibility to bring questions and requests to the table and gain an immediate response.

New for this year: the GPA also counts towards the zenon Certification. We're introducing this benefit to underline just how valuable the knowledge shared at this event is.

Find out more at [www.copadata.com/GPA](http://www.copadata.com/GPA)

LISETTE LILLO FAGERSTEDT,  
PARTNER PROGRAM MANAGER  
JOHANNES PETROWISCH,  
PARTNER ACCOUNT MANAGER

**Video: What our partners can expect at GPA 2016**  
Scan & Play!



<http://kaywa.me/Zgoz1>





# Energy from A to



<http://kaywa.me/80QQs>

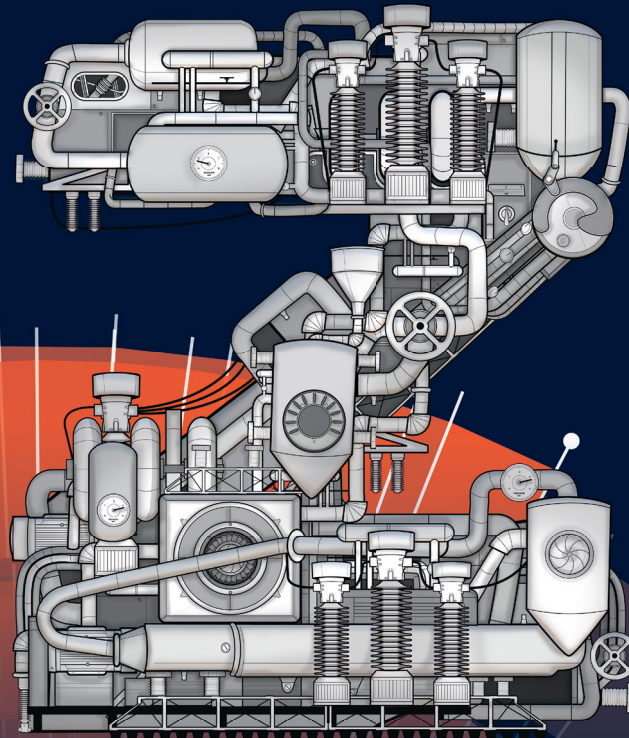

“What the ...?” Daniel was desperate. His new client’s substation project was nearly done, just when he noticed a mistake among the symbols. Now he had to tweak every single one of those 300 symbols again. Creating them by copying and pasting had been easy enough, but now, his time was running out.

After he barely kept his deadline, Daniel browsed the engineering forums. Although he couldn’t find a script against that kind of unpleasant surprise, he got a link for an Energy Automation System called zenon. And read about automatically colored topology, of SNMP and intelligent symbols.

Getting started with his test version took him a while. What was that feature inheritance after all? His first 300 symbols took him longer than expected, but the big breakthrough came afterwards: Changing a single symbol automatically altered all the others, too.

When checking his time sheet, Daniel had a redundancy of only few clicks. Topological coloring: integrated. All required protocols and standards like IEC 61850, IEC 60870 or DNP3: on board. Clear parameterizing, no single line of extra code. This program really did speak his language. So that’s how ergonomics worked. And that’s how relieving it felt.

**The Future is Ergonomics.  
Ergonomics is zenon.**

[www.the-future-is-ergonomics.com](http://www.the-future-is-ergonomics.com)



**COPADATA**  
do it your way